



# TABLE OF CONTENTS

## 1 2D collections

20 — 79

## 2 Volumes & Urban

80 — 155

## 3 Garlands

156 — 197

## 4 Decorations

198 — 239

## 5 Technical Pages

240 — 263

## 6 Motifs infos & contacts

264 — 272

◆ Height   ◆ Length   ■ Width   ↺ Voltage   🧑 Weight   ♻️ Recycled bottles needed to create a decoration   □ Print colour   ✨ Flash colour

### Blachere Illumination UK Ltd

Gladstone Place, Ladybank, Fife, KY15 7LB  
Tel: +44 (0)1337 832 910

Email: [sales@blachere-illumination.co.uk](mailto:sales@blachere-illumination.co.uk)

Design · Design dpt Blachere

Cover · Design dpt Blachere

### Photographers

- Michel Djaoui
- Lionel Moulet
- Jérémie Pitot
- Odile Pascal
- Brice Toul
- Eric Soltan
- Camille Moirenc



Print · Manufacture d'Histoire Deux-Ponts

### All rights reserved

Not a contract document. The sizes and wattages of motifs may be subject to change for technical reasons.  
Non-contractual images.

All our products are CE marked meaning that they meet electrical security norms and electromagnetic requirements.

All our motifs, designs and graphics are protected by the INPI, the OMPI and current industrial and intellectual property laws.

Reproduction of any kind, in full or part, is strictly forbidden without written authorisation of blachere illumination s.a.s.

get inspired at [www.blachere-illumination.com](http://www.blachere-illumination.com)

# MANIFESTO

We believe that illuminations bring more than just light to urban areas and living spaces.

We believe in their power to amaze, to enlighten and to create fairytales. The way we design and develop our illuminations incorporates those qualities in every detail.

We are committed to produce items of quality whilst doing our utmost to protect both the environment and humanity. Goodwill and an ethical approach are at the heart of our company's beliefs and can be found in all our projects worldwide.

We are Blachere and we have been producing illuminations with care and passion for 50 years.



# A BEAUTIFUL STORY



It all started in 1973, in Apt, when Jean-Paul Blachère lit up his first street. The locals' smiles and reactions confirmed that lighting has a unique magical power.

Lighting became his profession, one that he has pursued with dedication, creating a unique know-how and heritage that he has passed on.

For 50 years, we have been designing, creating and producing decor and illuminations in over 80 countries across the globe with as much enthusiasm as that very first day.

500 employees work every day to enhance cities around the world.



# 50<sup>th</sup>



Wherever our projects take us, we work with the same attention to illuminate the smallest village as the largest capital.

We understand and adapt to the needs and challenges of all cities, from Mexico to the US and Sweden.

Thanks to locally-based teams in 27 subsidiaries dotted around the world, we can meet the expectations of each city and the culture of each country so that our installations are as unique as they are practical.

**27 subsidiaries**  
**1000 city illuminations in**  
**more than 80 countries**  
**as well as 1000 shopping**  
**centres worldwide**



LIGHT UP  
THE WHOLE WORLD



### THE GLOBAL COMPACT

Launched in 2000, the United Nations Global Compact is the world's largest corporate responsibility initiative.

Blachere Illumination has been committed to the UN Global Compact's Corporate Social Responsibility initiative and its 10 Principles on human rights, labour standards, the environment and anti-corruption.



**70** Local networks  
**170** Countries  
**21 000** Participants



HUMAN RIGHTS



LABOUR



ENVIRONMENT



ANTI-CORRUPTION

### THE BLACHERE FOUNDATION

Our corporate foundation was created in 2004 by Jean-Paul Blachère and supports contemporary African creation and promotes artists from the continent. It presents exhibitions and hosts artists in residence at its art centre. It also arranges creative workshops in Africa and Europe and enters major African biennale exhibitions, including Dakar.



### «LE VILLAGE PRÉFÉRÉ DES FRANÇAIS» (The French's favourite village)

We are partners of the «Village Préféré des français». Having always contributed to the development of local economies and the influence of small municipalities, we are happy to have illuminated Esquelbecq (59) and Lavoûte-Chilhac (43), the municipalities that ranked 1st and 2nd in this competition.



# OUR COMMITMENTS

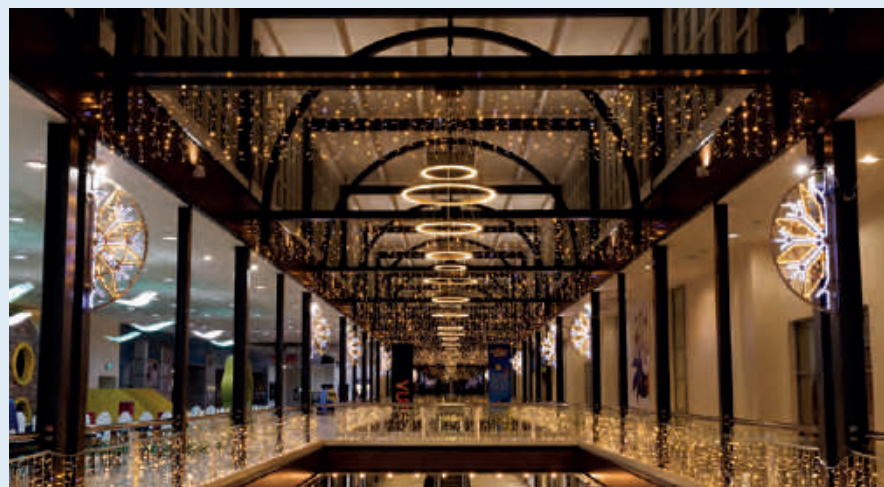

We love and appreciate that you are taking the time to flick through our catalogue. We hope it brings inspiration to you as we have poured our passion and 50 years of experience into the development of this product range.

A passionate team of 40 are here to bring your visions to life and enable your strategic aims to be fulfilled.

From the initial contact to the switch on of your display, we are all here to bring magic to your scheme.

Thanks to our three depots and remote sales team spread across the UK, we offer a local service. Combining our 50 years of experience as market leaders with your expert site specific knowledge, enables a bespoke process for any city, town, village, shopping centres, retail parks etc. With passion and experience we will understand the specific needs of each project to bring you magical experience.

**we have poured our passion and 50 years of experience into the development of this product range.**



Whether you have a specific vision, that we will use our manufacturing capabilities to bring to life or are starting out with a requirement to grow footfall. We can lead you to a successfully delivered scheme that will exceed your expectation while adhering to your budget requirements.

Relationships are important to us, that's why you'll always have someone to talk too at Blachere. Whether it's your dedicated local contact or any of our other team members, we provide our clients with four points of contact to promote great communication.

We are so proud of the sustainability focus we are continuing to develop at Blachere. No where else can you find such cleanly produced products. With more and more sectors turning to us to satisfy their own eco requirements, we are proudly leading the industry for a better tomorrow.

IN  
THE UK



Kings Road, London



The Shard London



Marylebone High Street, London



Multrees Walk, Edinburgh

We offer the complete package of design, manufacture and installation.

Due to our global scale, we can control the supply chain while bringing you a local approach.

All our 50 years of experience enables us to seamlessly bring your vision to life.

IN  
THE UK



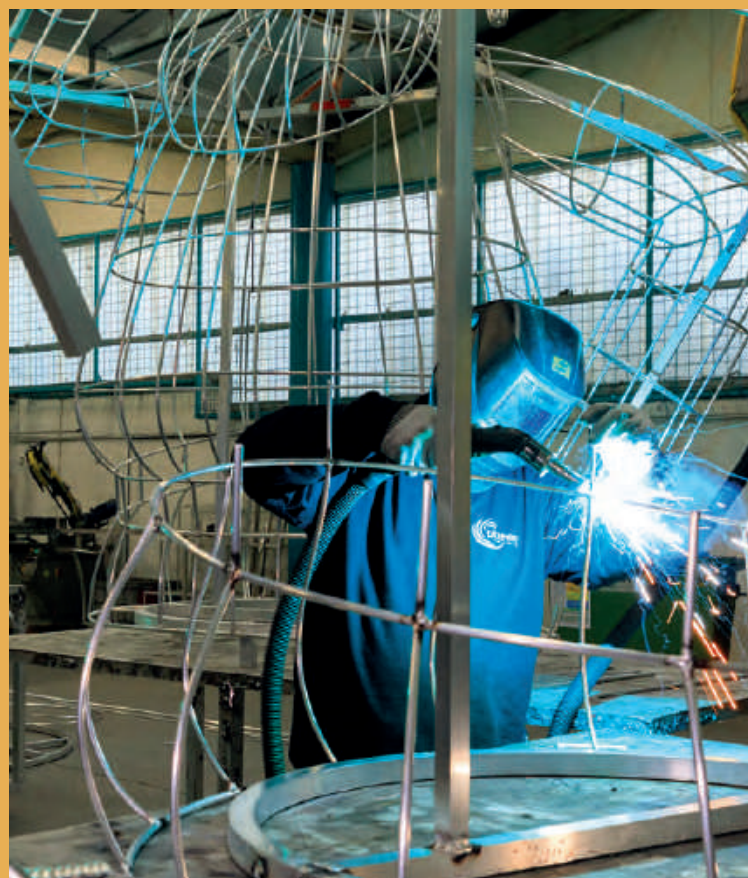

Everything starts with a pencil stroke... creation is the basis of all our projects.

In France and around the world, more than 30 designers imagine our decorations with care and passion.

They design the decorations of your cities and living spaces, proposing a hundred or so new designs each year to surprise you again and again.

Thanks to our innovations, we have found the right balance between ancestral know-how and industrialization:

From artistic ironwork to the most meticulous wiring, more than 7,000 custom-made decorations take shape in our workshops each year : The «Haute Couture» of illuminations.

At the same time, our catalogue decorations from our Summer and Winter collections are printed using plastic bottles manufactured in our workshop with 10 large-format robot printers. 435,000 eco-friendly decorations have been printed since 2016.

**10 large-format robot printers**

**5 sites of production**

**400 people in our international workshops**



FACE EACH  
CHALLENGE TOGETHER



Eco-responsibility is at the heart of our corporate strategy, and we are constantly thinking about innovation and the use of eco responsible materials more than ever before. Even if some of our ideas are off-the-cuff, our innovations are covered to numerous patents and all our creations are protected.

In order to respond with creativity and practicality to the new challenges posed by energy-saving needs and ecological issues, we continually design and produce ingenious solutions and tools.

After Bioprint, a recyclable and biodegradable material based on sugar cane, we are transitioning to a 100% Recyprint range of 300 decorations made from recycled plastic bottles.

Half of our research and development budget is allocated to ecoresponsible innovations.

**We have removed 80% of the aluminium in our 2D decorations, 100% Led low consumption for 20 years.**

Our 100% LED lighting components are also recycled after use and are all connectable via our Octoplus fast connection system.

In addition to our eco-responsible structures, we have devised some ingenious tools: TEMPO, SAVER & MASTER which make it possible to time, control and program decorations in both small towns and buzzing cities, resulting in cost-savings of over 50%!



**RECYPRINT STRUCTURE (PATENTED)**

plastic bottles

**ALUMINIUM FRAME**

recycled

**INTERCONNECTIVITY**

Octoplus & steering box

**RECYCLED ELECTRIC COMPONENTS**

Standardized and LEDS+



# REFINED CREATIVITY



# RECYPRINT

a plastic transformed into magical decorations



500 billion plastic bottles are produced each year, and many are discarded in the countryside or our oceans

At Blachere, we have found a way to transform PET (polyethylene terephthalate) into decors that are as stunning as they are innovative! Recycled bottles are sorted by colour and then ground into flakes. The resulting granules are then injected into our 3D printers to produce a unique decoration. This method helps to limit greenhouse gas emissions and prevent as many plastic bottles as possible from polluting land and seascapes.

Our innovations are protected by numerous patents.

Recyprint emits 10 times less CO2 than aluminum.

3,000,000 bottles have already been recycled into Christmas decorations.



## SORTING WASTE can be child's play



By encouraging today's youth to recycle is a major challenge that we have answered with creativity and fun. We have made this vital step a fun and playful collective act thanks to creating containers in the form of funny animals.

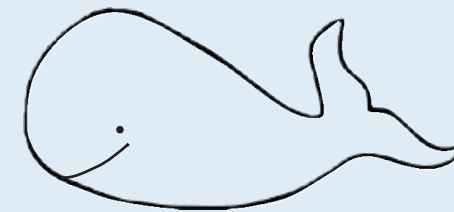

# BIOPRINT



when nature helps us to create our decor

A revolutionary material for creating structures that are **biodegradable, recyclable and coloured.**

Bioprint comes from a non-GMO bio-based sugar cane which is turned into dehydrated bioethanol in a French laboratory. The granules are dyed with clean dyes and this material is then injected into our 3D printers in our workshops, in order to produce biodegradable, recyclable and coloured structures.

This process limits manufacturing waste and allows for complete short-circuit recycling as we grind down our structures once they are no longer of use. Biodegradation is the decomposition of organic matter by microorganisms and has the advantage of minimising greenhouse gases.

Part of our range is made from Bioprint, **especially for our volumes and our Seasons & Urban range**

Biodegradation is the decomposition of organic matter by microorganisms, without causing damage to the natural environment.

Finally, our decorations biodegrade slowly, so they can be exposed to the outdoors for a long time without any aesthetic or mechanical alteration.

This slow process minimises the release of greenhouse gases emitted during the biodegradation of the complex molecules used in our revolutionary material.

Industrial composting makes it possible to optimise the intelligent management of this biomass, but recycling this material remains the most environmentally friendly option.

This eco-friendly process helps to minimise daily waste production.

OUR AVAILABLE COLOURS



Bioprint granule decomposition step



# COLLECTION *DESIGN*





N

**RIALTO**  
IPL272W  
IPL272

◆ 1.50m - ◆1.00m  
⚡ 24W - ⚖ 5.00kg - 📏26  
FLASH-XLED

N

**RIALTO**  
IPL272  
IPL272W

◆ 1.50m - ◆1.00m  
⚡ 24W - ⚖ 5.00kg - 📏26  
FLASH-XLED

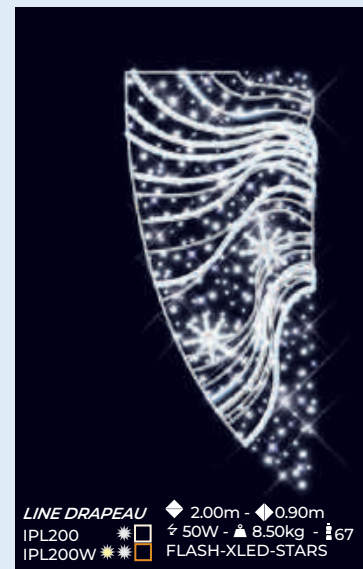
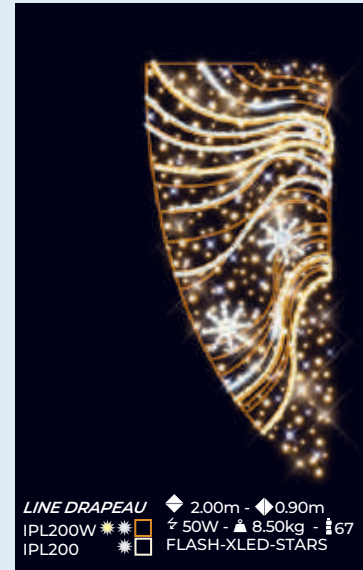
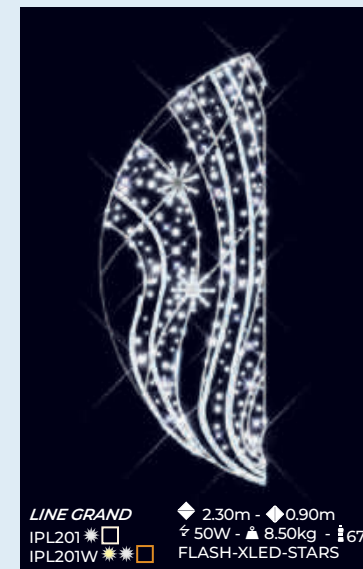
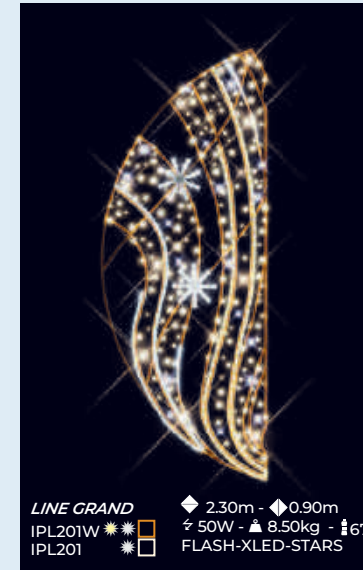
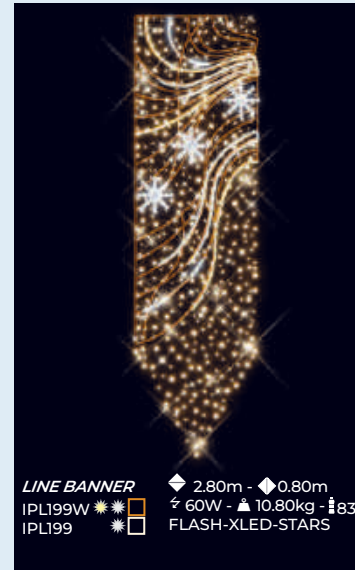
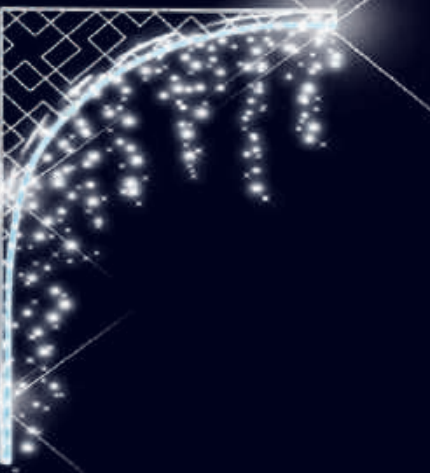

**LINE BANNER**  
IPL199W  
IPL199

◆ 2.80m - ◆0.80m  
⚡ 60W - ⚖ 10.80kg - 📏83  
FLASH-XLED-STARS

**LINE BANNER**  
IPL199  
IPL199W

◆ 2.80m - ◆0.80m  
⚡ 60W - ⚖ 10.80kg - 📏83  
FLASH-XLED-STARS

**LINE GRAND**  
IPL201W  
IPL201

◆ 2.30m - ◆0.90m  
⚡ 50W - ⚖ 8.50kg - 📏67  
FLASH-XLED-STARS

**LINE GRAND**  
IPL201  
IPL201W

◆ 2.30m - ◆0.90m  
⚡ 50W - ⚖ 8.50kg - 📏67  
FLASH-XLED-STARS

**LINE DRAPEAU**  
IPL200W  
IPL200

◆ 2.00m - ◆0.90m  
⚡ 50W - ⚖ 8.50kg - 📏67  
FLASH-XLED-STARS

**LINE DRAPEAU**  
IPL200  
IPL200W

◆ 2.00m - ◆0.90m  
⚡ 50W - ⚖ 8.50kg - 📏67  
FLASH-XLED-STARS



**QUADRILLE CHAIN** ◆ 1.24m - ◆6.00m  
 ITL161W \* \* \* \* \*  
 ITL161 \* \* \* \* \*  
 SLOWFLASH



**QUADRILLE ARC** ◆ 1.20m - ◆4.00m  
 ITL129W \* \* \* \* \*  
 ITL129 \* \* \* \* \*  
 STARS-SLOWFLASH

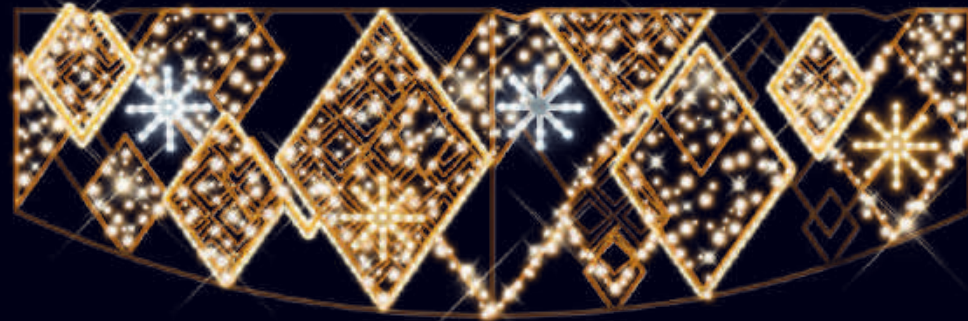

**QUADRILLE CURVE** ◆ 1.00m - ◆3.00m  
 ITL130W \* \* \* \* \*  
 ITL130 \* \* \* \* \*  
 STARS-SLOWFLASH



**QUADRILLE UNIT** ◆ 0.80m - ◆0.73m  
 ITL291W \* \* \* \* \*  
 ITL291 \* \* \* \* \*  
 SLOWFLASH-STARS-XLED

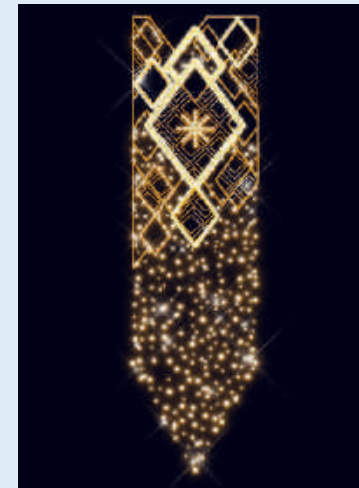

**QUADRILLE BANNER** ◆ 2.80m - ◆0.80m  
 IPL131W \* \* \* \* \*  
 IPL131 \* \* \* \* \*  
 STARS-SLOWFLASH

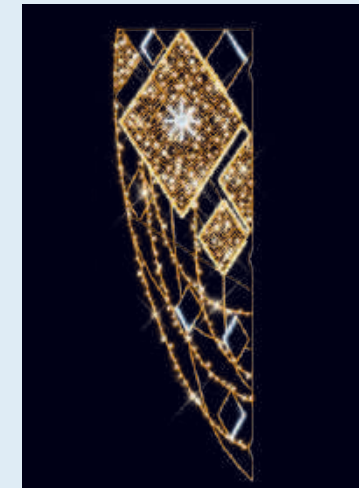

**QUADRILLE GRAND** ◆ 3.00m - ◆1.00m  
 IPL144W \* \* \* \* \*  
 IPL144 \* \* \* \* \*  
 STARS-SLOWFLASH-XLED

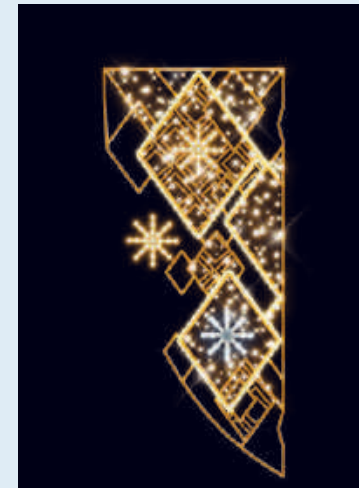

**QUADRILLE** ◆ 2.00m - ◆0.90m  
 IPL129W \* \* \* \* \*  
 IPL129 \* \* \* \* \*  
 STARS-SLOWFLASH



**QUADRILLE ROLL** ◆ 1.30m - ◆1.00m  
 IPL230W \* \* \* \* \*  
 IPL230 \* \* \* \* \*  
 XLED - STARS-FLASH

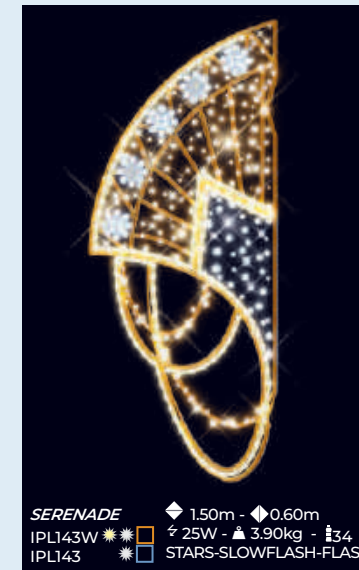

**SERENADE** ◆ 1.50m - ◆0.60m  
 IPL143W \* \* \* \* \*  
 IPL143 \* \* \* \* \*  
 STARS-SLOWFLASH-FLASH

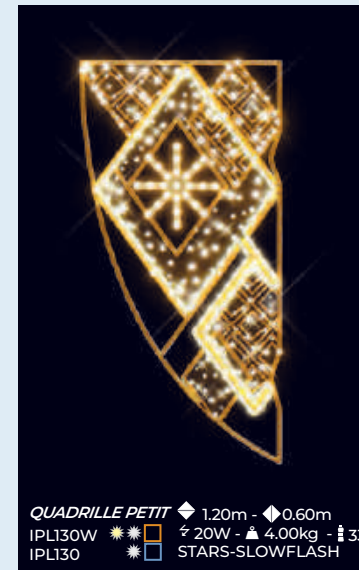

**QUADRILLE PETIT** ◆ 1.20m - ◆0.60m  
 IPL130W \* \* \* \* \*  
 IPL130 \* \* \* \* \*  
 STARS-SLOWFLASH

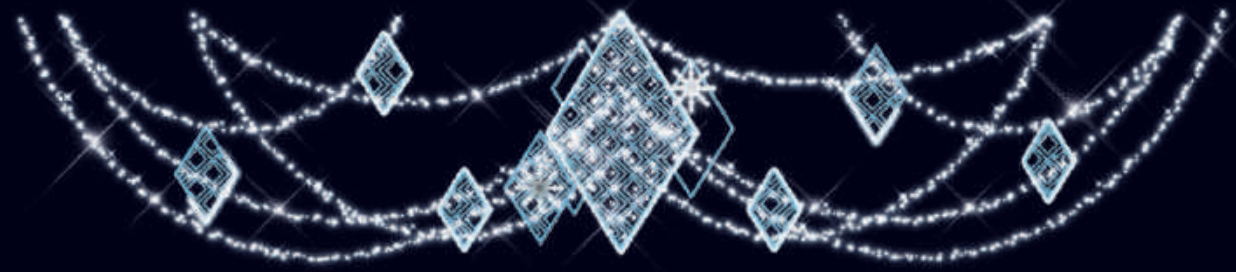

**QUADRILLE CHAIN** ◆ 1.24m - ◆ 6.00m  
 ITL161 \* □ ◆ 90W - ▲ 25.50kg - 116  
 ITL161W \* \* □ XLED - STARS - FLASH



**QUADRILLE JF** ◆ 0.80m - ◆ 4.50m  
 ITL233 \* □ ◆ 105W - ▲ 15.10kg - 166  
 XLED - FLASH - STARS



**QUADRILLE ARC** ◆ 1.20m - ◆ 4.00m  
 ITL129 \* □ ◆ 100W - ▲ 18.00kg - 132  
 ITL129W \* \* □ STARS - SLOWFLASH

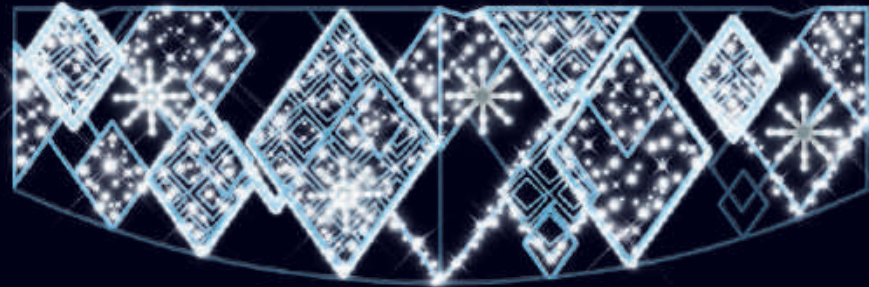

**QUADRILLE CURVE** ◆ 1.00m - ◆ 3.00m  
 ITL130 \* □ ◆ 80W - ▲ 15.10kg - 114  
 ITL130W \* \* □ STARS - SLOWFLASH

TO ORDER



**QUADRILLE UNIT** ◆ 0.80m - ◆ 0.73m  
 ITL291 \* □ ◆ 217W - ▲ 6.00kg - 120  
 ITL291W \* □ SLOWFLASH - STARS - XLED

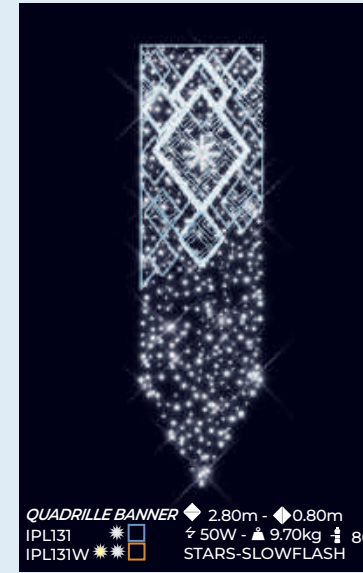

**QUADRILLE BANNER** ◆ 2.80m - ◆ 0.80m  
 IPL131 \* □ ◆ 50W - ▲ 9.70kg - 80  
 IPL131W \* \* □ STARS - SLOWFLASH



**QUADRILLE** ◆ 2.00m - ◆ 0.90m  
 IPL129 \* □ ◆ 40W - ▲ 7.60kg - 57  
 IPL129W \* \* □ STARS - SLOWFLASH



**QUADRILLE ROLL** ◆ 1.30m - ◆ 1.00m  
 IPL230 \* □ ◆ 25W - ▲ 5.00kg - 45  
 IPL230W \* \* □ XLED - STARS - FLASH

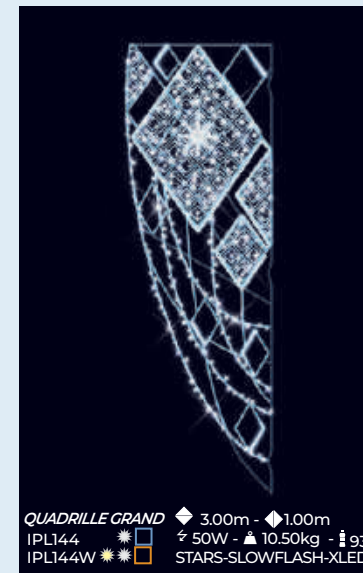

**QUADRILLE GRAND** ◆ 3.00m - ◆ 1.00m  
 IPL144 \* □ ◆ 50W - ▲ 10.50kg - 93  
 IPL144W \* \* □ STARS - SLOWFLASH - XLED



**QUADRILLE PETIT** ◆ 1.20m - ◆ 0.60m  
 IPL130 \* □ ◆ 20W - ▲ 4.00kg - 33  
 IPL130W \* \* □ STARS - SLOWFLASH

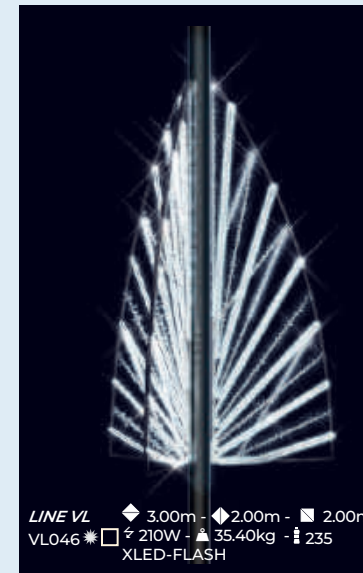

**LINE VL** ◆ 3.00m - ◆ 2.00m - 2.00m  
 VL046 \* □ ◆ 210W - ▲ 35.40kg - 235  
 XLED - FLASH



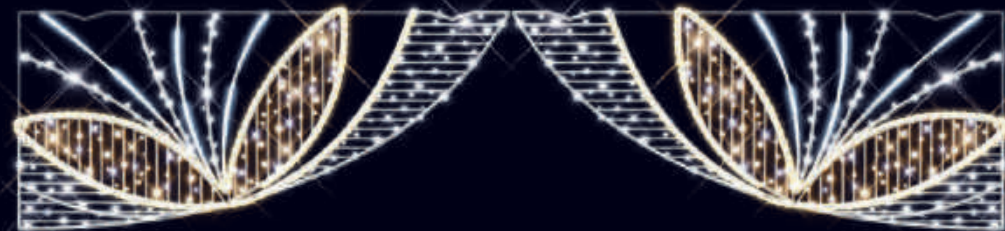

**COIMBRA DOUBLE**  
ITL226W \* \* □  
◆ 0.90m - ◆ 4.00m  
⚡ 80W - ⚡ 14.50kg - ⚡ 111  
XLED - FLASH SLOWFLASH



**LINE JF**  
ITL232W \* \* \* □  
◆ 1.00m - ◆ 4.00m  
⚡ 120W - ⚡ 17.00kg - ⚡ 83  
XLED - STARS



**JF**  
ITL009 \* \* □  
ITL061 \* \* □  
◆ 0.90m - ◆ 3.50m  
⚡ 80W - ⚡ 10.90kg - ⚡ 106



**COIMBRA BANNER**  
IPL202W \* \* \* □  
◆ 2.80m - ◆ 0.80m  
⚡ 60W - ⚡ 12.00kg - ⚡ 43  
FLASH-XLED-SLOWFLASH

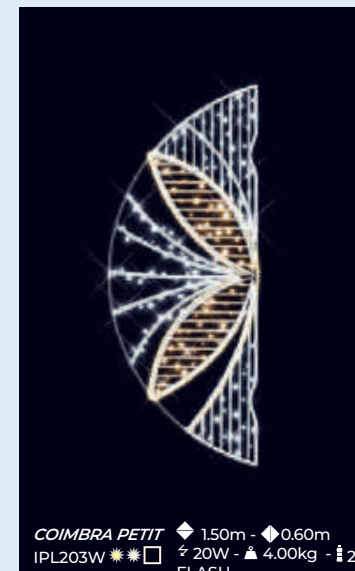

**COIMBRA PETIT**  
IPL203W \* \* \* □  
◆ 1.50m - ◆ 0.60m  
⚡ 20W - ⚡ 4.00kg - ⚡ 22  
FLASH



**ROMANE**  
IPL101W \* \* \* □  
◆ 2.30m - ◆ 0.70m  
⚡ 50W - ⚡ 6.60kg - ⚡ 55  
STARS-XLED-SLOWFLASH

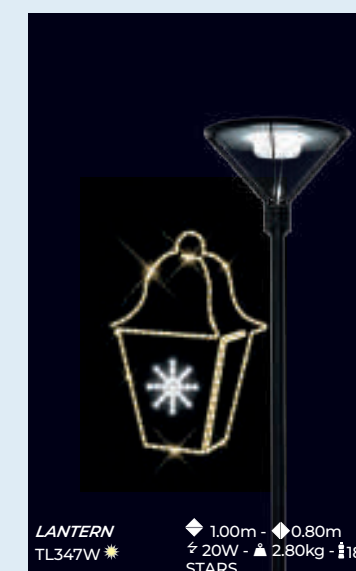

**LANTERN**  
TL347W \*  
◆ 1.00m - ◆ 0.80m  
⚡ 20W - ⚡ 2.80kg - ⚡ 183  
STARS

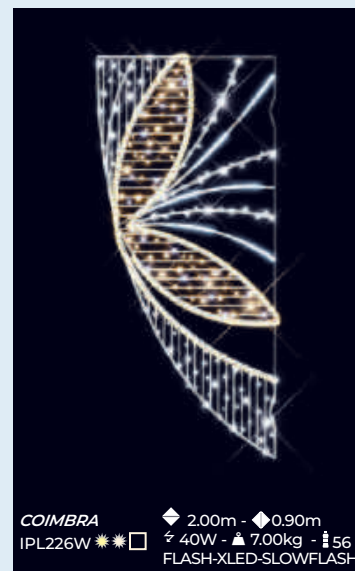

**COIMBRA**  
IPL226W \* \* \* □  
◆ 2.00m - ◆ 0.90m  
⚡ 40W - ⚡ 7.00kg - ⚡ 56  
FLASH-XLED-SLOWFLASH

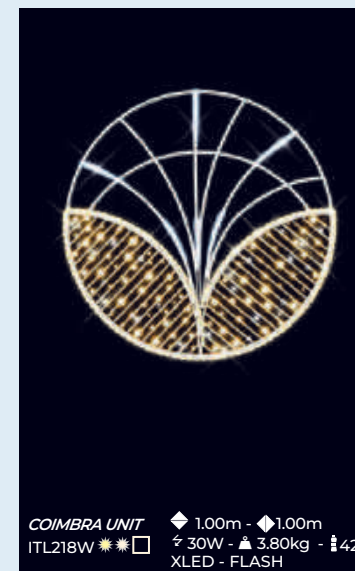

**COIMBRA UNIT**  
ITL218W \* \* \* □  
◆ 1.00m - ◆ 1.00m  
⚡ 30W - ⚡ 3.80kg - ⚡ 42  
XLED - FLASH

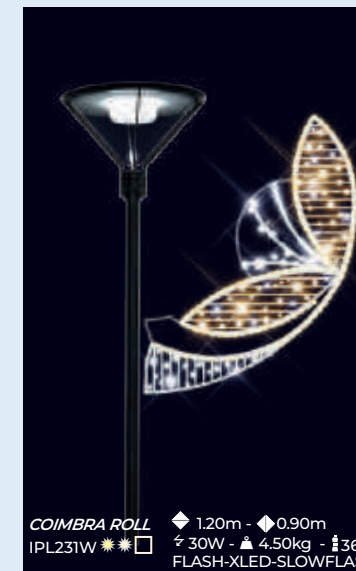

**COIMBRA ROLL**  
IPL231W \* \* \* □  
◆ 1.20m - ◆ 0.90m  
⚡ 30W - ⚡ 4.50kg - ⚡ 36  
FLASH-XLED-SLOWFLASH

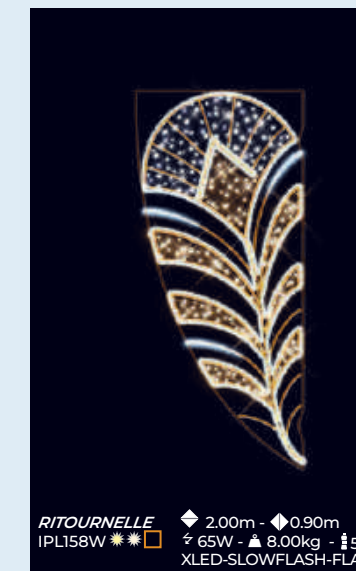

**RITOURNELLE**  
IPL158W \* \* \* □  
◆ 2.00m - ◆ 0.90m  
⚡ 65W - ⚡ 8.00kg - ⚡ 54  
XLED-SLOWFLASH-FLASH



# COLLECTION *CLASSIC*



# DUO COLORS® COLLECTION

2 in 1 products!

Switch your decor from warm white to pure white according to your desires!



You can choose from a warm white or pure white.

By reversing the connectors, you can obtain either a pure white decor/ pure white flash or a warm white decor/warm white flash.

**N**

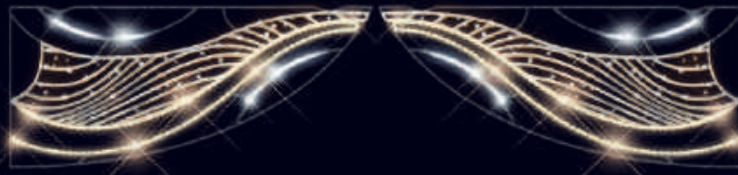

**N**



**DUO DOUBLE**  
ITL282DC

◆ 0.90m - ◆ 4.00m  
⚡ 18W - ▲ 6.00kg - 📏 40  
XLED-FLASH

**N**



**N**



**DUO FLAKE**  
ITL288DC

◆ 1.00m - ◆ 1.00m  
⚡ 303W - ▲ 14.00kg - 📏 214  
FLASH



**N**



**N**



**DUO LINE**  
IPL283DC

◆ 1.50m - ◆ 0.70m  
⚡ 81W - ▲ 4.00kg - 📏 58  
FLASH-XLED

**N**



**N**



**DUO PETIT**  
IPL285DC

◆ 1.50m - ◆ 0.60m  
⚡ 21W - ▲ 4.00kg - 📏 67  
FLASH-XLED

**N**



**N**

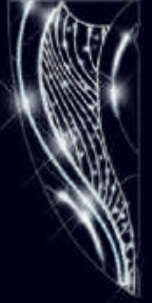

**DUO LINE GRAND**  
IPL282DC

◆ 2.00m - ◆ 0.90m  
⚡ 152W - ▲ 7.00kg - 📏 107  
FLASH-XLED

**N**

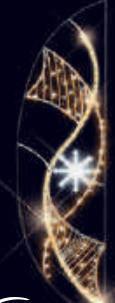

**N**

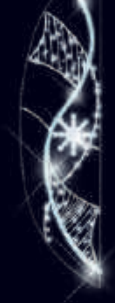

**DUO**  
IPL286DC

◆ 2.10m - ◆ 0.52m  
⚡ 80W - ▲ 5.00kg - 📏 69  
FLASH-STARS

**N**



**N**



**DUO GRANDE**  
IPL284DC

◆ 3.00m - ◆ 1.00m  
⚡ 285W - ▲ 10.00kg - 📏 150  
FLASH



**RHAPSODY DOUBLE**  
ITL033W \* \* □  
**TO ORDER**

◆ 1.60m - ◆ 6.00m  
⚡ 185W - ⚙ 28.60kg - ⚡ 235  
FLASH



**BOLCHOI**  
ITL077W \* \* □

◆ 1.20m - ◆ 6.00m  
⚡ 160W - ⚙ 25.30kg - ⚡ 235  
XLED-SLOWFLASH



**FLORA DOUBLE**  
ITL135W \* □

◆ 1.00m - ◆ 6.00m  
⚡ 130W - ⚙ 26.00kg - ⚡ 187  
STARS-SLOWFLASH



**FLORA DOUBLE**  
ITL135 \* □

◆ 1.00m - ◆ 6.00m  
⚡ 130W - ⚙ 26.00kg - ⚡ 187  
STARS-SLOWFLASH

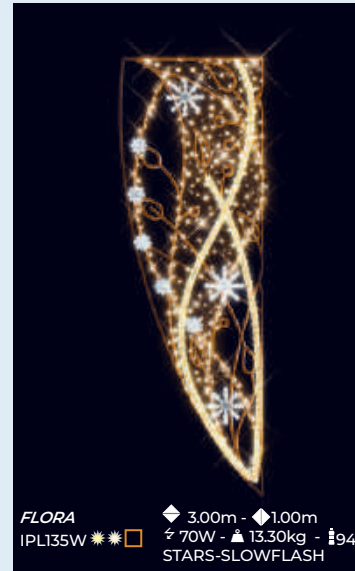

**FLORA**  
IPL135W \* \* □

◆ 3.00m - ◆ 1.00m  
⚡ 70W - ⚙ 13.30kg - ⚡ 94  
STARS-SLOWFLASH

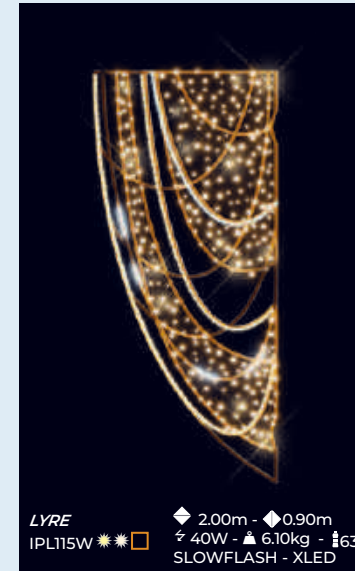

**LYRE**  
IPL115W \* \* □

◆ 2.00m - ◆ 0.90m  
⚡ 40W - ⚙ 6.10kg - ⚡ 63  
SLOWFLASH - XLED



**FLORA**  
IPL135 \* □

◆ 3.00m - ◆ 1.00m  
⚡ 70W - ⚙ 13.30kg - ⚡ 94  
STARS-SLOWFLASH

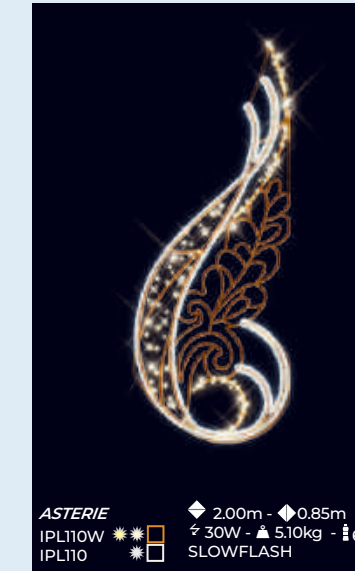

**ASTERIE**  
IPL110W \* \* □  
IPL110

◆ 2.00m - ◆ 0.85m  
⚡ 30W - ⚙ 5.10kg - ⚡ 60  
SLOWFLASH

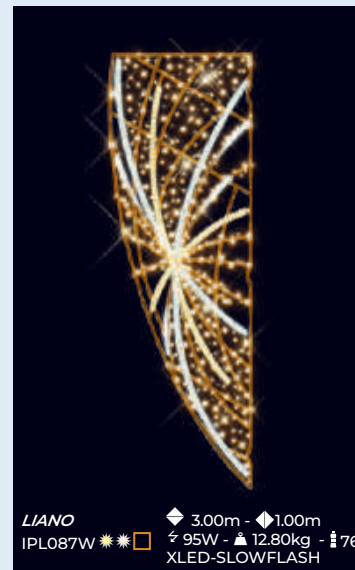

**LIANO**  
IPL087W \* \* □

◆ 3.00m - ◆ 1.00m  
⚡ 95W - ⚙ 12.80kg - ⚡ 76  
XLED-SLOWFLASH

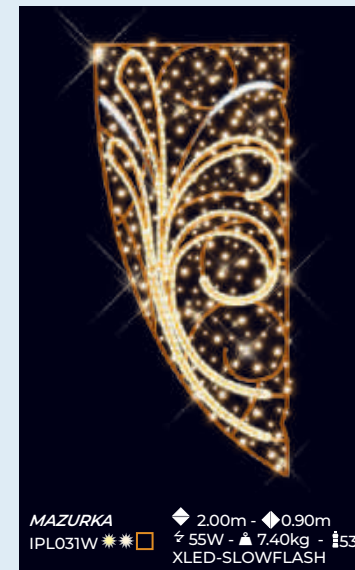

**MAZURKA**  
IPL031W \* \* □

◆ 2.00m - ◆ 0.90m  
⚡ 55W - ⚙ 7.40kg - ⚡ 53  
XLED-SLOWFLASH

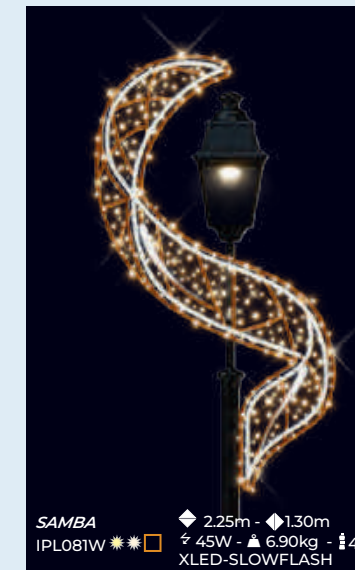

**SAMBA**  
IPL081W \* \* □

◆ 2.25m - ◆ 1.30m  
⚡ 45W - ⚙ 6.90kg - ⚡ 43  
XLED-SLOWFLASH



**LIBRETTO**  
IPL082W \* \* □

◆ 1.20m - ◆ 0.60m  
⚡ 30W - ⚙ 3.50kg - ⚡ 33  
XLED-SLOWFLASH

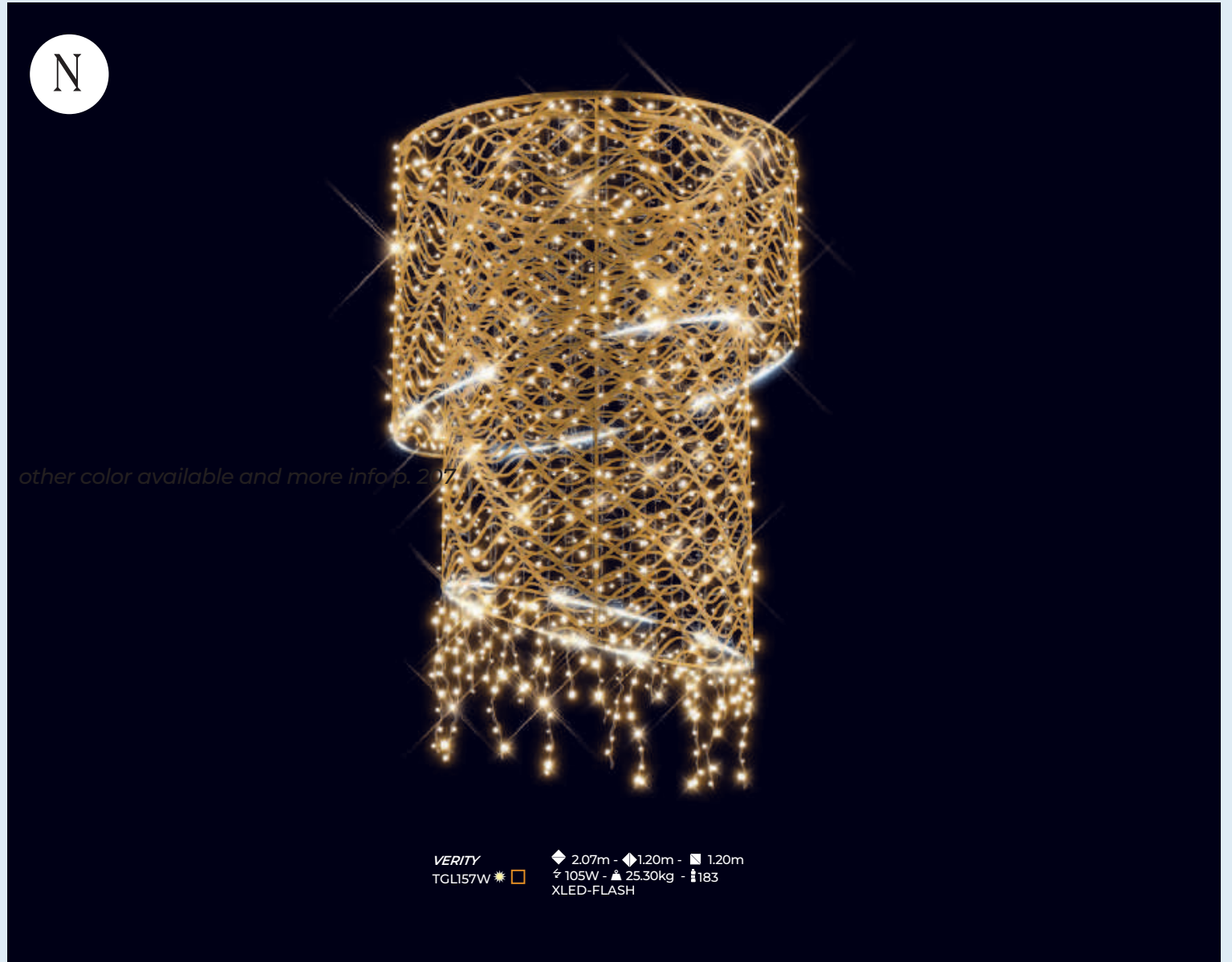
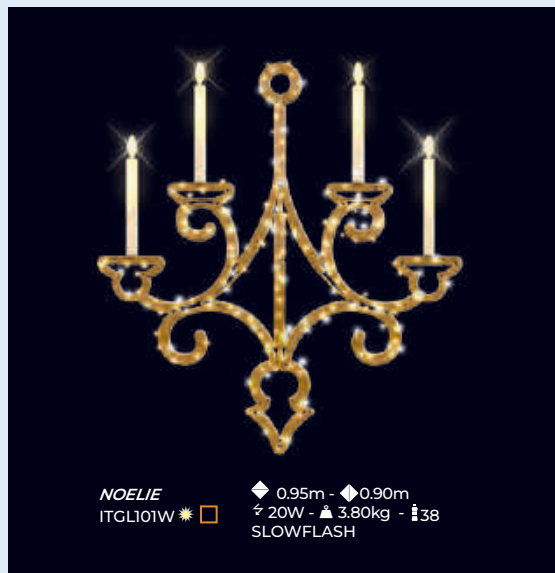
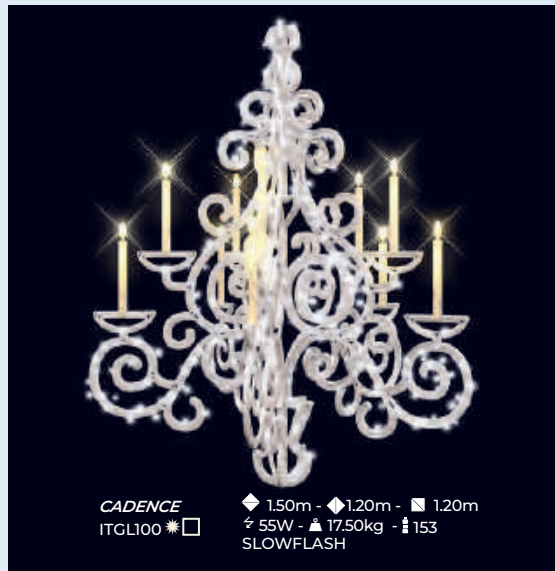
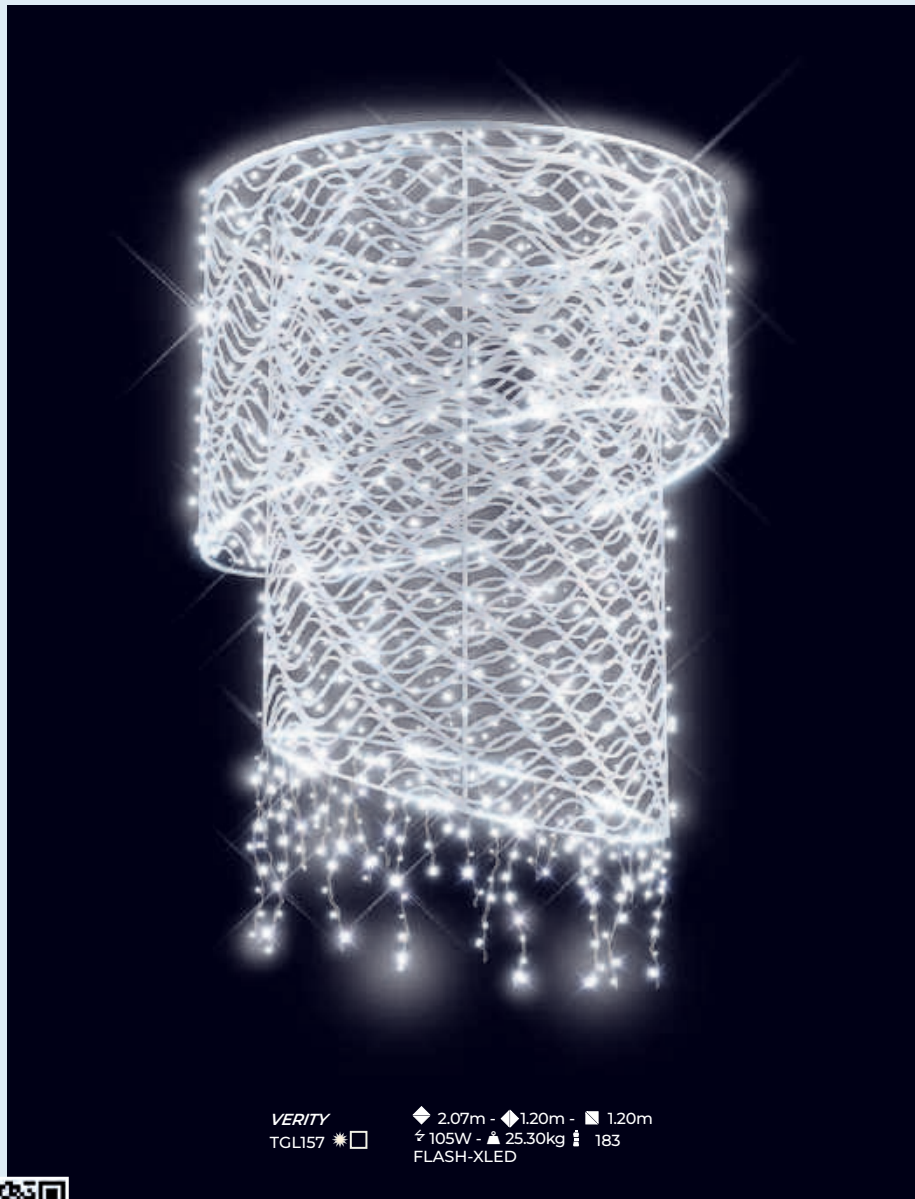



**CAJUN JF**  
ITL043W

◆ 1.55m - ◆ 4.60m  
⚡ 270W - ▲ 28.20kg - ⚡ 175  
FLASH

TO ORDER



**MILO ARC**  
ITL127W   
ITL127

◆ 1.20m - ◆ 4.00m  
⚡ 110W - ▲ 17.40kg - ⚡ 116  
STARS-FLASH

TO ORDER



**MILO ARC**  
ITL127   
ITL127W

◆ 1.20m - ◆ 4.00m  
⚡ 110W - ▲ 17.40kg - ⚡ 116  
STAR-FLASH



**BOLERO ARC**  
ITL132W

◆ 1.20m - ◆ 4.00m  
⚡ 135W - ▲ 19.50kg - ⚡ 162  
XLED-SLOWFLASH

TO ORDER

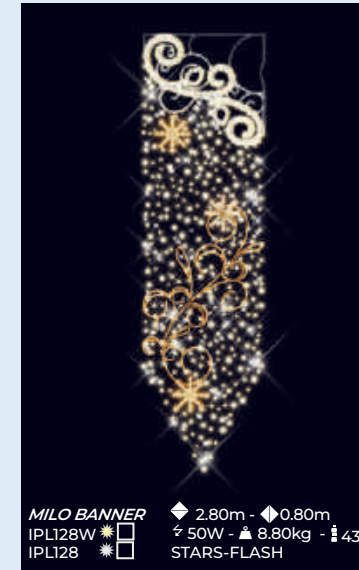

**MILO BANNER**  
IPL128W   
IPL128

◆ 2.80m - ◆ 0.80m  
⚡ 50W - ▲ 8.80kg - ⚡ 43  
STARS-FLASH



**TWIST**  
IPL133

◆ 1.20m - ◆ 0.60m  
⚡ 35W - ▲ 3.90kg - ⚡ 33  
SLOWFLASH

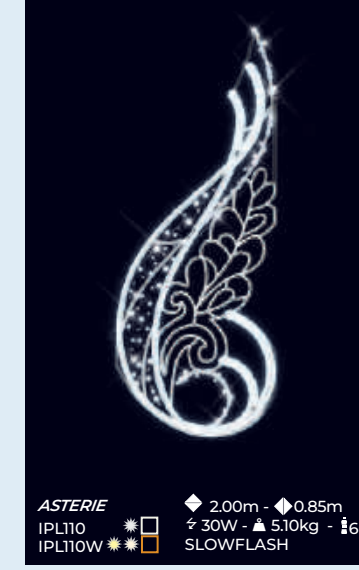

**ASTERIE**  
IPL110   
IPL110W

◆ 2.00m - ◆ 0.85m  
⚡ 30W - ▲ 5.10kg - ⚡ 60  
SLOWFLASH

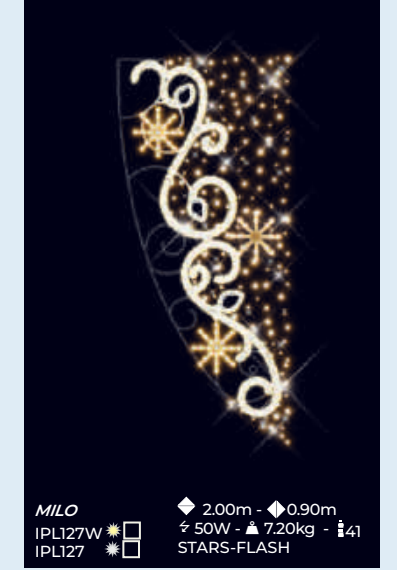

**MILO**  
IPL127W   
IPL127

◆ 2.00m - ◆ 0.90m  
⚡ 50W - ▲ 7.20kg - ⚡ 41  
STARS-FLASH

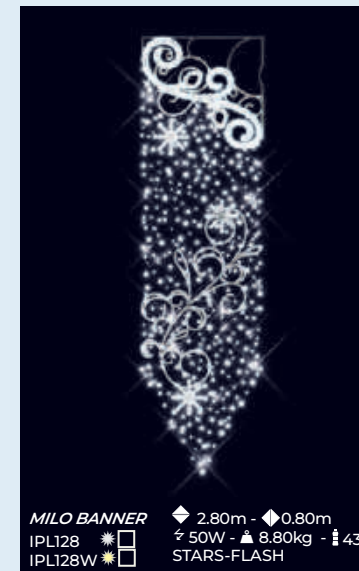

**MILO BANNER**  
IPL128   
IPL128W

◆ 2.80m - ◆ 0.80m  
⚡ 50W - ▲ 8.80kg - ⚡ 43  
STARS-FLASH

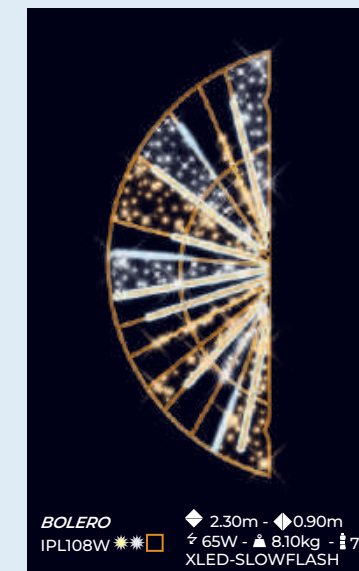

**BOLERO**  
IPL108W

◆ 2.30m - ◆ 0.90m  
⚡ 65W - ▲ 8.10kg - ⚡ 70  
XLED-SLOWFLASH

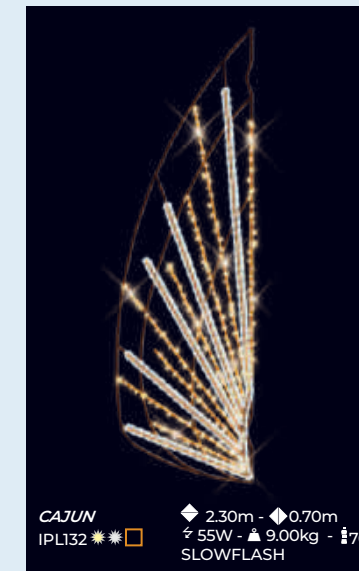

**CAJUN**  
IPL132

◆ 2.30m - ◆ 0.70m  
⚡ 55W - ▲ 9.00kg - ⚡ 70  
SLOWFLASH

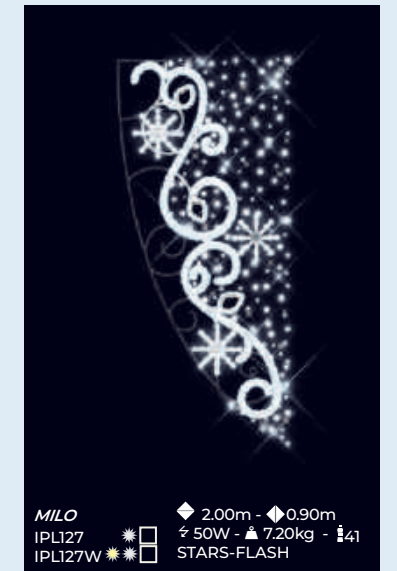

**MILO**  
IPL127   
IPL127W

◆ 2.00m - ◆ 0.90m  
⚡ 50W - ▲ 7.20kg - ⚡ 41  
STARS-FLASH

# Joyeuses Fêtes

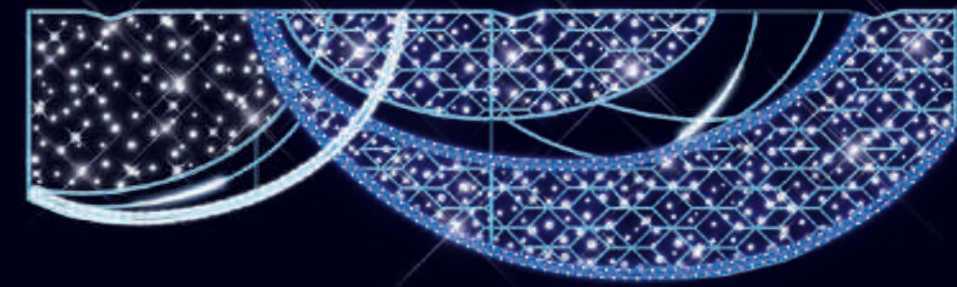

**JF**  
ITL061  
ITL009

◆ 0.90m - ◆ 3.50m  
⚡ 80W - ⚙ 10.80kg - 📏 106

**EWAN**  
ITL166B  
ITL166R  
ITL166W

◆ 1.00m - ◆ 3.00m  
⚡ 70W - ⚙ 11.10kg - 📏 98  
XLED-SLOWFLASH-FLASH

**TO ORDER**

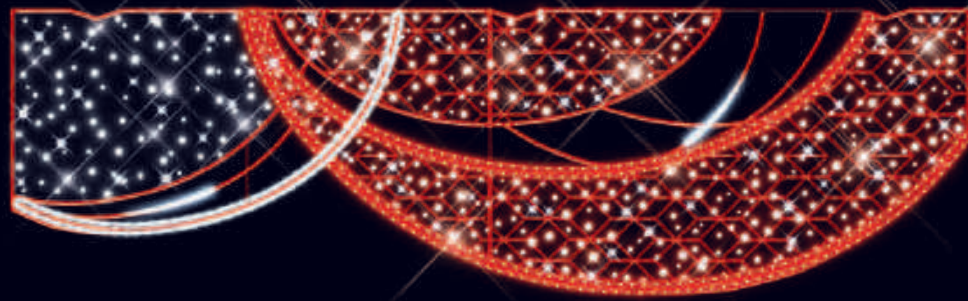

**EWAN**  
ITL166R  
ITL166B  
ITL166W

◆ 1.00m - ◆ 3.00m  
⚡ 70W - ⚙ 11.10kg - 📏 98  
XLED-SLOWFLASH-FLASH

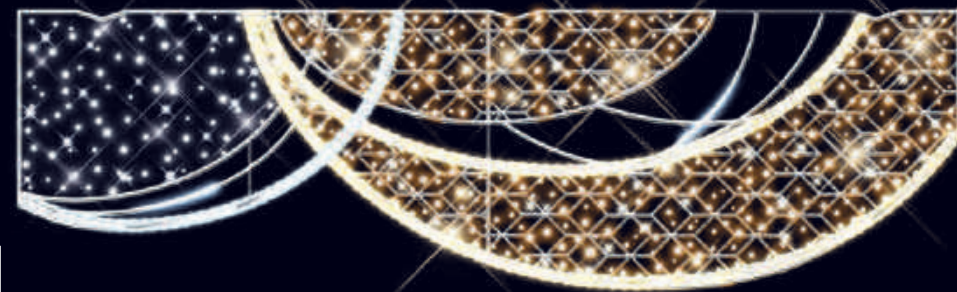

**EWAN**  
ITL166W  
ITL166R  
ITL166B

◆ 1.00m - ◆ 3.00m  
⚡ 70W - ⚙ 11.10kg - 📏 98  
XLED-FLASH

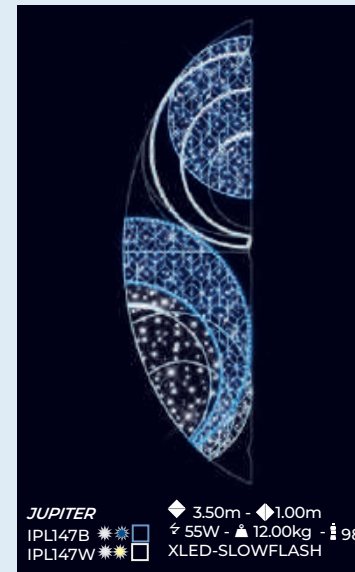

**JUPITER**  
IPL147B  
IPL147W

◆ 3.50m - ◆ 1.00m  
⚡ 55W - ⚙ 12.00kg - 📏 98  
XLED-SLOWFLASH

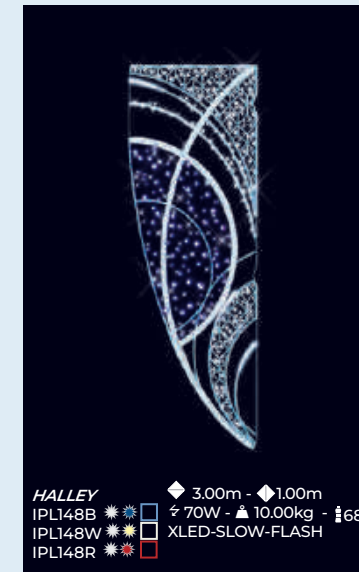

**HALLEY**  
IPL148B  
IPL148W  
IPL148R

◆ 3.00m - ◆ 1.00m  
⚡ 70W - ⚙ 10.00kg - 📏 68  
XLED-SLOW-FLASH

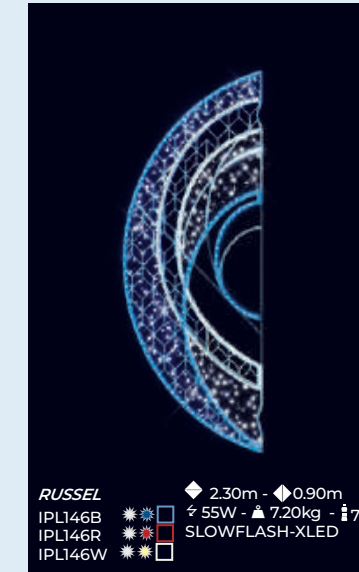

**RUSSEL**  
IPL146B  
IPL146R  
IPL146W

◆ 2.30m - ◆ 0.90m  
⚡ 55W - ⚙ 7.20kg - 📏 74  
SLOWFLASH-XLED

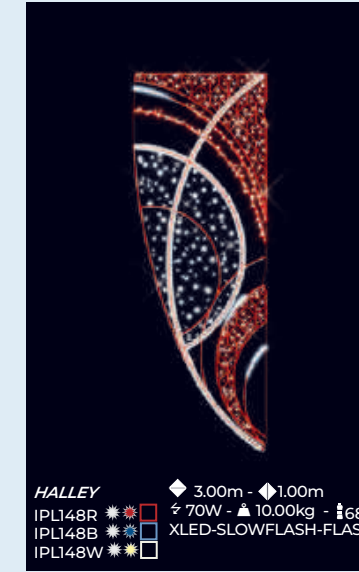

**HALLEY**  
IPL148R  
IPL148B  
IPL148W

◆ 3.00m - ◆ 1.00m  
⚡ 70W - ⚙ 10.00kg - 📏 68  
XLED-SLOWFLASH-FLASH

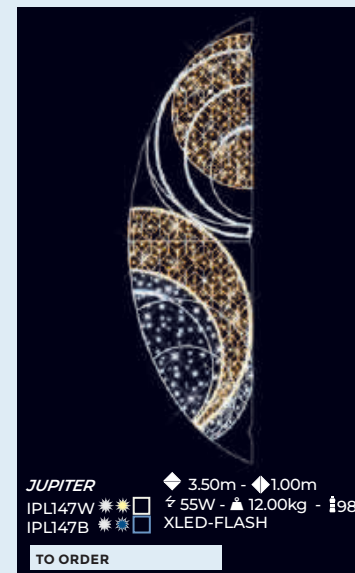

**JUPITER**  
IPL147W  
IPL147B

◆ 3.50m - ◆ 1.00m  
⚡ 55W - ⚙ 12.00kg - 📏 98  
XLED-FLASH

**TO ORDER**

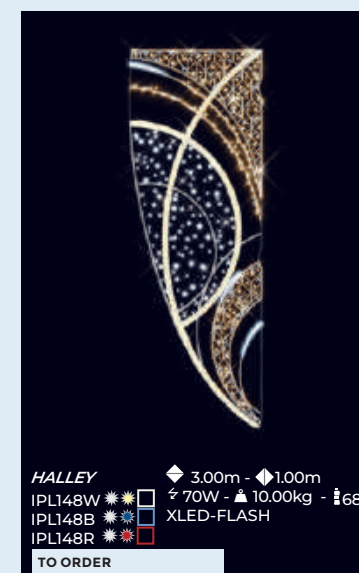

**HALLEY**  
IPL148W  
IPL148B  
IPL148R

◆ 3.00m - ◆ 1.00m  
⚡ 70W - ⚙ 10.00kg - 📏 68  
XLED-FLASH

**TO ORDER**

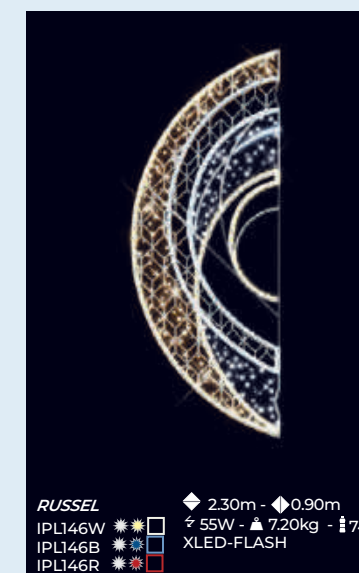

**RUSSEL**  
IPL146W  
IPL146B  
IPL146R

◆ 2.30m - ◆ 0.90m  
⚡ 55W - ⚙ 7.20kg - 📏 74  
XLED-FLASH

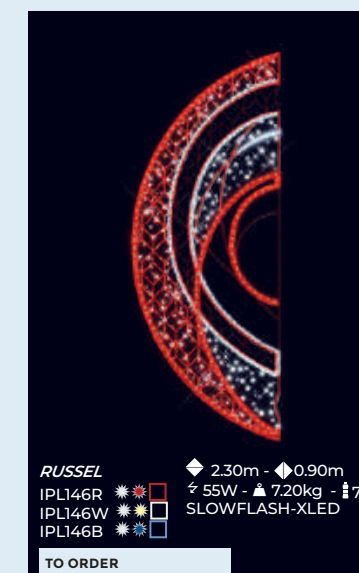

**RUSSEL**  
IPL146R  
IPL146W  
IPL146B

◆ 2.30m - ◆ 0.90m  
⚡ 55W - ⚙ 7.20kg - 📏 74  
SLOWFLASH-XLED

**TO ORDER**



**CLELIA DOUBLE**  
ITL120  
ITL120W  
ITL120R  
ITL120B

◆ 1.00m - ◆ 6.00m  
⚡ 115W - ▲ 23.40kg - ⚡ 179  
SLOWFLASH



**CLELIA DOUBLE**  
ITL120W  
ITL120R  
ITL120B  
ITL120

◆ 1.00m - ◆ 6.00m  
⚡ 115W - ▲ 23.40kg - ⚡ 179  
SLOWFLASH



**CLELIA DOUBLE**  
ITL120R  
ITL120B  
ITL120W  
ITL120

◆ 1.00m - ◆ 6.00m  
⚡ 115W - ▲ 23.40kg - ⚡ 179  
SLOWFLASH



**CLELIA DOUBLE**  
ITL120B  
ITL120R  
ITL120W  
ITL120

◆ 1.00m - ◆ 6.00m  
⚡ 115W - ▲ 23.40kg - ⚡ 179  
SLOWFLASH

TO ORDER

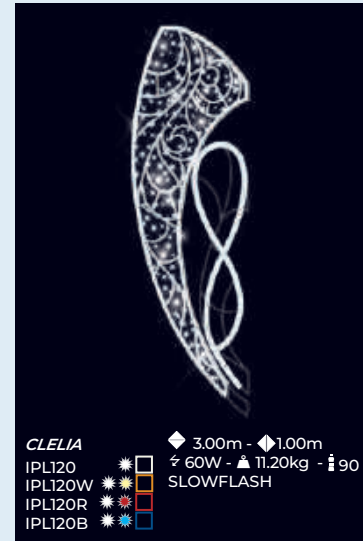

**CLELIA**  
IPL120  
IPL120W  
IPL120R  
IPL120B

◆ 3.00m - ◆ 1.00m  
⚡ 60W - ▲ 11.20kg - ⚡ 90  
SLOWFLASH

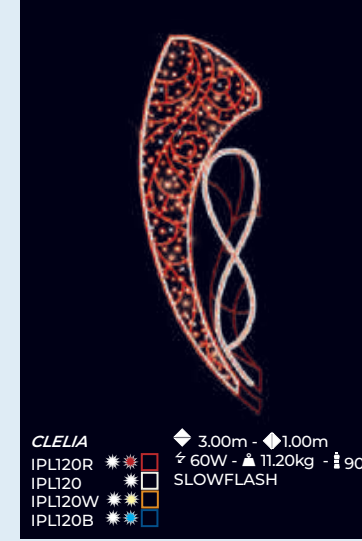

**CLELIA**  
IPL120R  
IPL120  
IPL120W  
IPL120B

◆ 3.00m - ◆ 1.00m  
⚡ 60W - ▲ 11.20kg - ⚡ 90  
SLOWFLASH



**CLELIA**  
IPL120W  
IPL120  
IPL120R  
IPL120B

◆ 3.00m - ◆ 1.00m  
⚡ 60W - ▲ 11.20kg - ⚡ 90  
SLOWFLASH

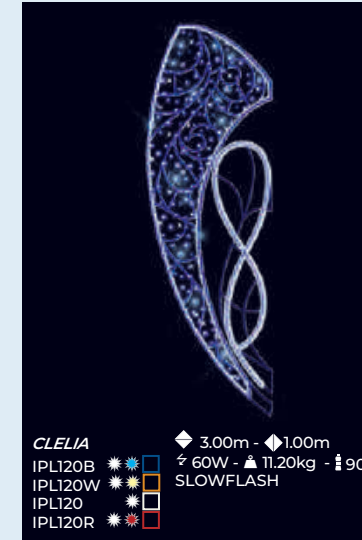

**CLELIA**  
IPL120B  
IPL120W  
IPL120  
IPL120R

◆ 3.00m - ◆ 1.00m  
⚡ 60W - ▲ 11.20kg - ⚡ 90  
SLOWFLASH

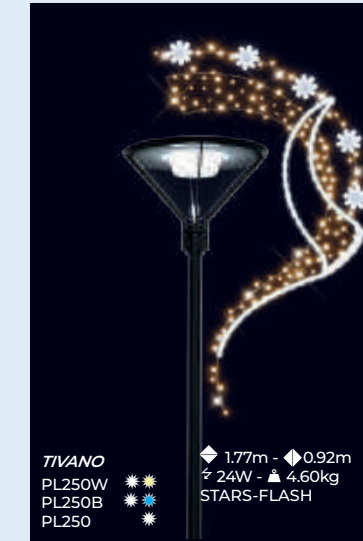

**TIVANO**  
PL250W  
PL250B  
PL250

◆ 1.77m - ◆ 0.92m  
⚡ 24W - ▲ 4.60kg  
STARS-FLASH

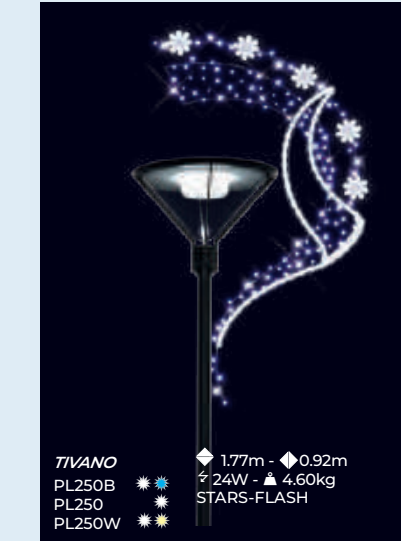

**TIVANO**  
PL250B  
PL250  
PL250W

◆ 1.77m - ◆ 0.92m  
⚡ 24W - ▲ 4.60kg  
STARS-FLASH

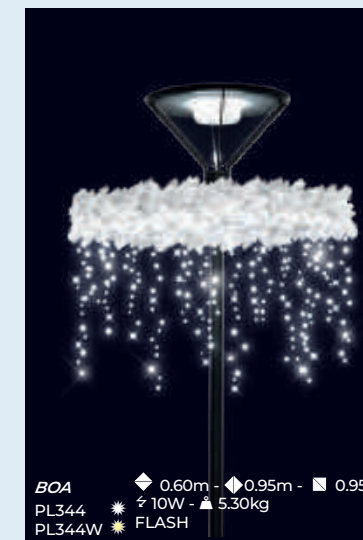

**BOA**  
PL344  
PL344W

◆ 0.60m - ◆ 0.95m - ■ 0.95m  
⚡ 10W - ▲ 5.30kg  
FLASH

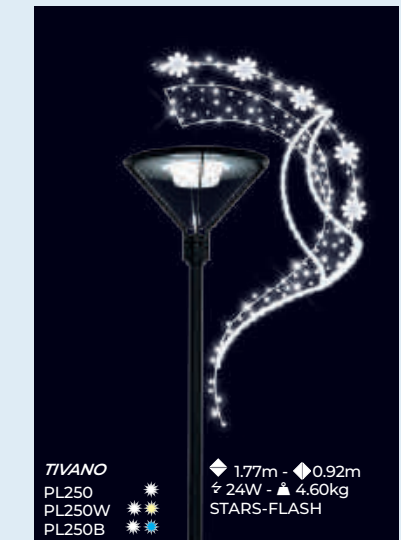

**TIVANO**  
PL250  
PL250W  
PL250B

◆ 1.77m - ◆ 0.92m  
⚡ 24W - ▲ 4.60kg  
STARS-FLASH



# COLLECTION *ALTO*





N

**ROMAN CURVE**  
ITL262W \* \* \* \*  
ITL262 \* \* \* \*  
ITL262B \* \* \* \*

◆ 1.00m - ◆ 4.00m  
⚡ 64W - ⚡ 17.00kg - ⚡ 101  
SLOWFLASH-STARS



N

**ROMAN CURVE**  
ITL262 \* \* \* \*  
ITL262W \* \* \* \*  
ITL262B \* \* \* \*

◆ 1.00m - ◆ 4.00m  
⚡ 64W - ⚡ 17.00kg - ⚡ 101  
SLOWFLASH-STARS

**TO ORDER**



N

**ROMAN CURVE**  
ITL262B \* \* \* \*  
ITL262 \* \* \* \*  
ITL262W \* \* \* \*

◆ 1.00m - ◆ 4.00m  
⚡ 64W - ⚡ 17.00kg - ⚡ 101  
SLOWFLASH-STARS



N

**ROMAN UNIT**  
ITL261W \* \* \* \*  
ITL261 \* \* \* \*  
ITL261B \* \* \* \*

◆ 1.00m - ◆ 0.86m  
⚡ 21W - ⚡ 5.00kg - ⚡ 18  
SLOWFLASH-STARS



N

**ROMAN UNIT**  
ITL261 \* \* \* \*  
ITL261B \* \* \* \*  
ITL261W \* \* \* \*

◆ 1.00m - ◆ 0.86m  
⚡ 21W - ⚡ 5.00kg - ⚡ 18  
SLOWFLASH-STARS

**TO ORDER**



N

**ROMAN UNIT**  
ITL261B \* \* \* \*  
ITL261W \* \* \* \*  
ITL261 \* \* \* \*

◆ 1.00m - ◆ 0.86m  
⚡ 21W - ⚡ 5.00kg - ⚡ 18  
SLOWFLASH-STARS

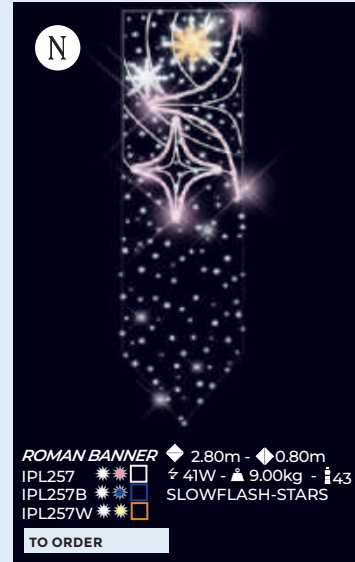

N

**ROMAN BANNER** ◆ 2.80m - ◆ 0.80m  
IPL257 \* \* \* \* ⚡ 41W - ⚡ 9.00kg - ⚡ 43  
IPL257B \* \* \* \*  
IPL257W \* \* \* \*  
SLOWFLASH-STARS

**TO ORDER**

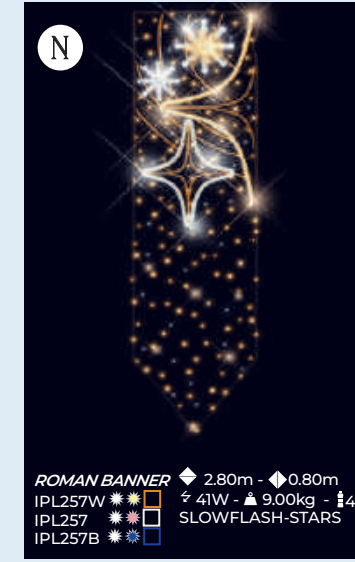

N

**ROMAN BANNER** ◆ 2.80m - ◆ 0.80m  
IPL257W \* \* \* \* ⚡ 41W - ⚡ 9.00kg - ⚡ 43  
IPL257 \* \* \* \*  
IPL257B \* \* \* \*  
SLOWFLASH-STARS

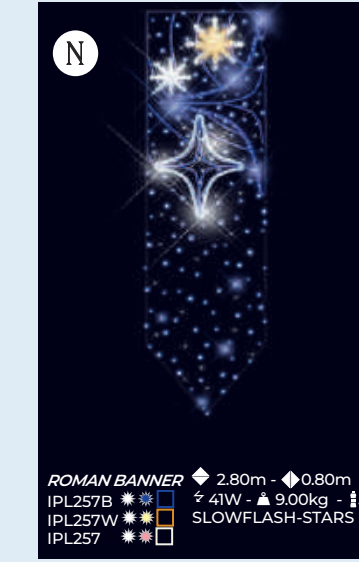

N

**ROMAN BANNER** ◆ 2.80m - ◆ 0.80m  
IPL257B \* \* \* \* ⚡ 41W - ⚡ 9.00kg - ⚡ 43  
IPL257W \* \* \* \*  
IPL257 \* \* \* \*  
SLOWFLASH-STARS

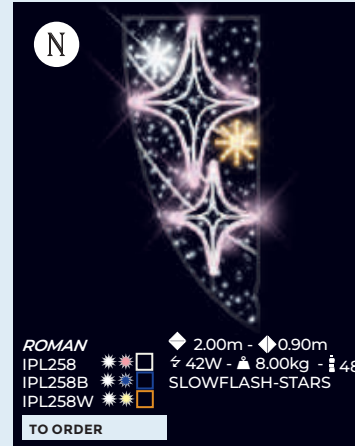

N

**ROMAN** ◆ 2.00m - ◆ 0.90m  
IPL258 \* \* \* \* ⚡ 42W - ⚡ 8.00kg - ⚡ 48  
IPL258B \* \* \* \*  
IPL258W \* \* \* \*  
SLOWFLASH-STARS

**TO ORDER**

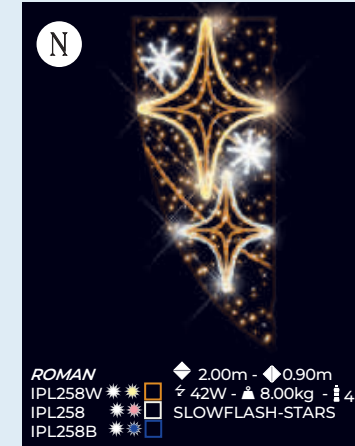

N

**ROMAN** ◆ 2.00m - ◆ 0.90m  
IPL258W \* \* \* \* ⚡ 42W - ⚡ 8.00kg - ⚡ 48  
IPL258 \* \* \* \*  
IPL258B \* \* \* \*  
SLOWFLASH-STARS

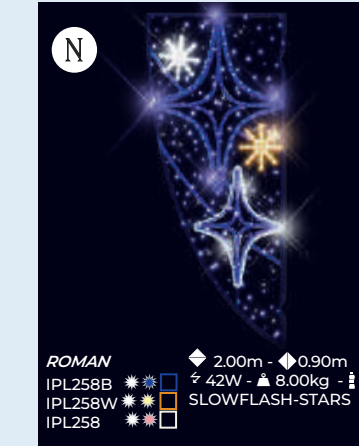

N

**ROMAN** ◆ 2.00m - ◆ 0.90m  
IPL258B \* \* \* \* ⚡ 42W - ⚡ 8.00kg - ⚡ 48  
IPL258W \* \* \* \*  
IPL258 \* \* \* \*  
SLOWFLASH-STARS

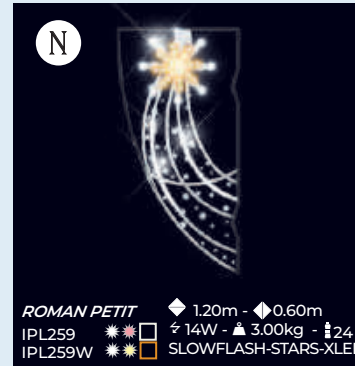

N

**ROMAN PETIT** ◆ 1.20m - ◆ 0.60m  
IPL259 \* \* \* \* ⚡ 14W - ⚡ 3.00kg - ⚡ 24  
IPL259W \* \* \* \*  
SLOWFLASH-STARS-XLED

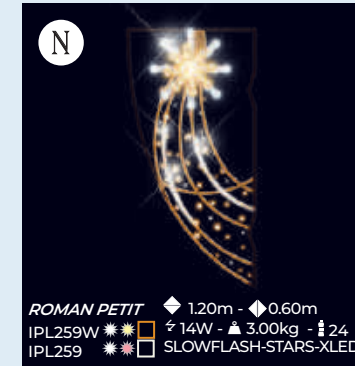

N

**ROMAN PETIT** ◆ 1.20m - ◆ 0.60m  
IPL259W \* \* \* \* ⚡ 14W - ⚡ 3.00kg - ⚡ 24  
IPL259 \* \* \* \*  
SLOWFLASH-STARS-XLED



N

**ROMAN ROLL** ◆ 1.30m - ◆ 1.00m  
IPL260W \* \* \* \* ⚡ 14W - ⚡ 4.00kg  
STARS



**THORN CHAIN**  
ITL163 \* \* □  
◆ 1.24m - ◆ 6.00m  
⚡ 115W - ⚖ 26.50kg - 📏 194  
XLED-SLOWFLASH-STARS



**VENTURO DOUBLE**  
ITL160 \* □  
◆ 1.00m - ◆ 6.00m  
⚡ 130W - ⚖ 22.60kg - 📏 197  
FLASH



**APELIOTE**  
ITL167 \* \* □  
**TO ORDER**  
◆ 1.20m - ◆ 4.00m  
⚡ 150W - ⚖ 22.50kg - 📏 166  
STARS



**ASIA CURVE**  
ITL126 \* \* □  
◆ 1.00m - ◆ 3.00m  
⚡ 100W - ⚖ 16.30kg - 📏 201  
STARS-SLOWFLASH

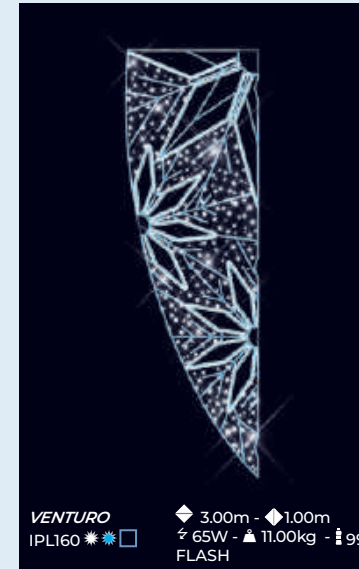

**VENTURO**  
IPL160 \* \* □  
◆ 3.00m - ◆ 1.00m  
⚡ 65W - ⚖ 11.00kg - 📏 99  
FLASH

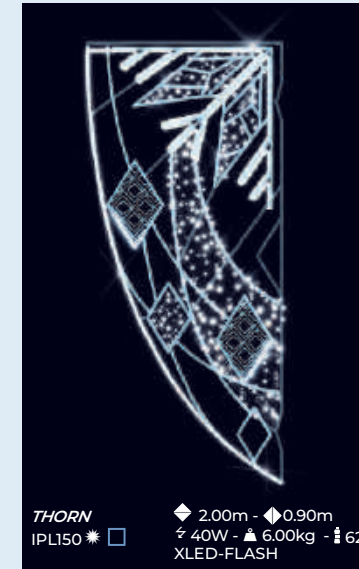

**THORN**  
IPL150 \* □  
◆ 2.00m - ◆ 0.90m  
⚡ 40W - ⚖ 6.00kg - 📏 62  
XLED-FLASH



**ASIA**  
IPL126 \* \* □  
IPL126W \* \* □  
◆ 1.50m - ◆ 0.60m  
⚡ 40W - ⚖ 5.40kg - 📏 62  
SLOWFLASH

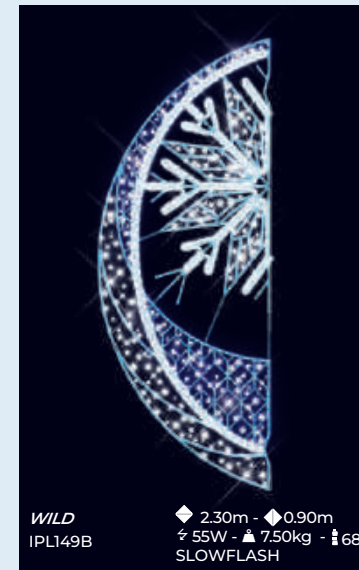

**WILD**  
IPL149B  
◆ 2.30m - ◆ 0.90m  
⚡ 55W - ⚖ 7.50kg - 📏 68  
SLOWFLASH



**ALTHAIR**  
IPL122 \* □  
◆ 1.50m - ◆ 0.70m  
⚡ 30W - ⚖ 4.20kg - 📏 54  
STARS-SLOWFLASH



**SERENADE**  
IPL143 \* \* □  
IPL143W \* \* □  
◆ 1.50m - ◆ 0.60m  
⚡ 25W - ⚖ 3.90kg - 📏 34  
STARS-SLOWFLASH



**VENUS DOUBLE**  
ITL028B \* \* □  
◆ 1.00m - ◆ 6.00m  
⚡ 150W - ⚡ 25.30kg - ⚡ 187  
STARS-SLOWFLASH



**FOREST**  
ITL105 \* \* □  
◆ 1.20m - ◆ 5.00m  
⚡ 110W - ⚡ 24.70kg - ⚡ 214  
XLED-STARS-SLOWFLASH



**CHARLESTON DOUBLE**  
ITL035 \* □  
◆ 0.87m - ◆ 5.28m  
⚡ 100W - ⚡ 19.90kg - ⚡ 147  
STARS-FLASH



**CHARLESTON**  
IPL035 \* □  
◆ 2.71m - ◆ 0.88m  
⚡ 50W - ⚡ 10.30kg - ⚡ 74  
STARSFLASH



**WOOD**  
IPL124 \* □  
◆ 2.00m - ◆ 0.90m  
⚡ 15W - ⚡ 5.00kg - ⚡ 49  
SLOWFLASH

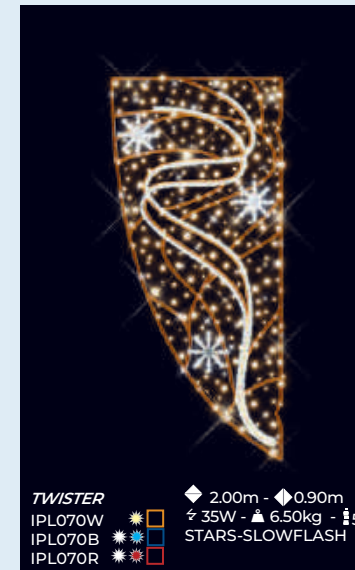

**TWISTER**  
IPL070W \* □  
IPL070B \* \* □  
IPL070R \* \* □  
◆ 2.00m - ◆ 0.90m  
⚡ 35W - ⚡ 6.50kg - ⚡ 51  
STARS-SLOWFLASH

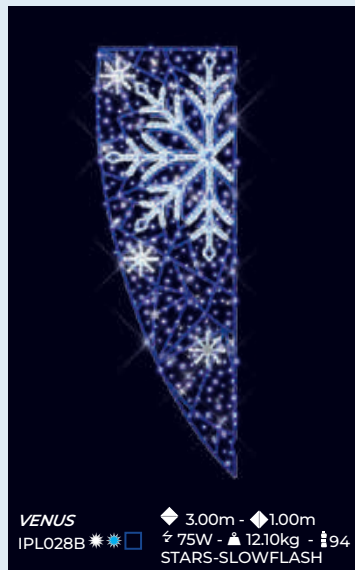

**VENUS**  
IPL028B \* \* □  
◆ 3.00m - ◆ 1.00m  
⚡ 75W - ⚡ 12.10kg - ⚡ 94  
STARS-SLOWFLASH



**ZEPHYR**  
IPL075B \* \* □  
IPL075W \* \* □  
◆ 2.50m - ◆ 0.90m  
⚡ 60W - ⚡ 8.20kg - ⚡ 76  
XLED-SLOWFLASH

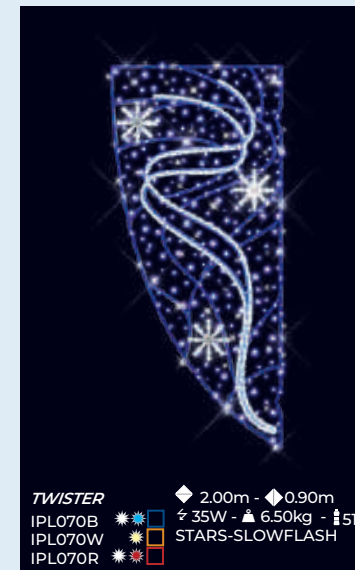

**TWISTER**  
IPL070B \* \* □  
IPL070W \* \* □  
IPL070R \* \* □  
◆ 2.00m - ◆ 0.90m  
⚡ 35W - ⚡ 6.50kg - ⚡ 51  
STARS-SLOWFLASH



**MIA**  
ITL102  
ITL102W  
◆ 1,00m - ◆ 1,00m  
⚡ 45W - ⚖ 5,80kg - 📏 73  
SLOWFLASH



**DENDRA**  
ITL022  
ITL022W  
◆ 0,97m - ◆ 0,85m  
⚡ 30W - ⚖ 3,00kg - 📏 41



**MIA**  
ITL102W  
ITL102  
◆ 1,00m - ◆ 1,00m  
⚡ 45W - ⚖ 5,80kg - 📏 73  
SLOWFLASH



**DENDRA**  
ITL022W  
ITL022  
◆ 0,97m - ◆ 0,85m  
⚡ 30W - ⚖ 3,00kg - 📏 41



**GIVRE**  
ITL020B  
ITL020W  
◆ 0,97m - ◆ 0,85m  
⚡ 40W - ⚖ 4,50kg - 📏 47  
SLOWFLASH



**LILLY**  
ITL115  
ITL115W  
◆ 0,48m - ◆ 0,42m  
⚡ 16W - ⚖ 4,00kg - 📏 20



**GIVRE**  
ITL020W  
ITL020B  
◆ 0,97m - ◆ 0,85m  
⚡ 40W - ⚖ 4,50kg - 📏 47  
FLASH



**LILLY**  
ITL115W  
ITL115  
◆ 0,48m - ◆ 0,42m  
⚡ 16W - ⚖ 4,00kg - 📏 20



**GRAND MIA**  
ITL101  
ITL101W  
◆ 2,00m - ◆ 2,00m  
⚡ 150W - ⚖ 18,00kg - 📏 216  
SLOWFLASH



**AIGUILLE**  
ITL021  
◆ 1,25m - ◆ 1,25m  
⚡ 55W - ⚖ 4,60kg - 📏 65



**GRAND MIA**  
ITL101W  
ITL101  
◆ 2,00m - ◆ 2,00m  
⚡ 150W - ⚖ 18,00kg - 📏 216  
SLOWFLASH

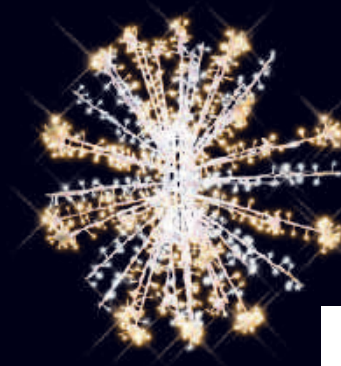

**BELLA**  
TGL139W  
◆ 1,50m - ◆ 1,50m - ■ 1,50m  
⚡ 120W - ⚖ 18,30kg  
FLASH



 Easily transform any hanging decoration into a polemount decoration, thanks to our accessory: PIX01 (see p256)



**ALYZE DOUBLE**  
ITL072W \*\*\*□  
◆ 1.00m - ◆ 6.00m  
⚡ 120W - ⚖ 24.50kg - 📏 203  
STARS-XLED-SLOWFLASH



**GRAND BLIZZARD**  
ITL118W \*\*\*□  
◆ 1.00m - ◆ 5.00m  
⚡ 135W - ⚖ 24.00kg - 📏 224  
STARS-SLOWFLASH



**CASSIOPEE DOUBLE**  
ITL076W \*\*\*□  
◆ 1.00m - ◆ 6.00m  
⚡ 120W - ⚖ 23.40kg - 📏 187  
XLED-SLOWFLASH



**JOYEUSES FETES VOLUTUS**  
ITL059W \*\*\*□  
◆ 1.22m - ◆ 4.93m  
⚡ 155W - ⚖ 23.60kg - 📏 132  
FLASH-STARS

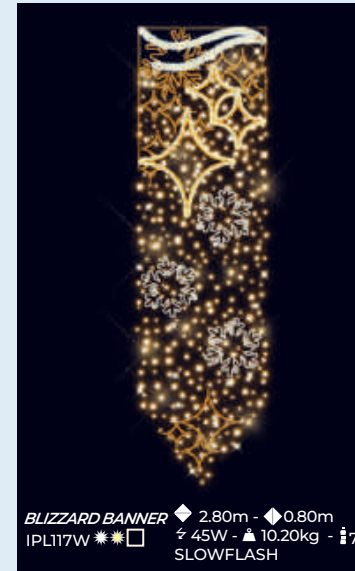

**BLIZZARD BANNER**  
IPL117W \*\*\*□  
◆ 2.80m - ◆ 0.80m  
⚡ 45W - ⚖ 10.20kg - 📏 76  
SLOWFLASH

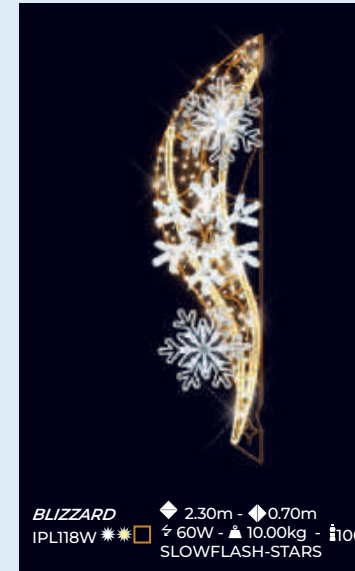

**BLIZZARD**  
IPL118W \*\*\*□  
◆ 2.30m - ◆ 0.70m  
⚡ 60W - ⚖ 10.00kg - 📏 100  
SLOWFLASH-STARS

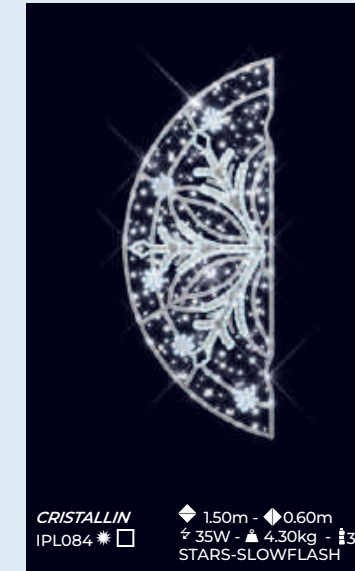

**CRISTALLIN**  
IPL084 \*\*\*□  
◆ 1.50m - ◆ 0.60m  
⚡ 35W - ⚖ 4.30kg - 📏 35  
STARS-SLOWFLASH

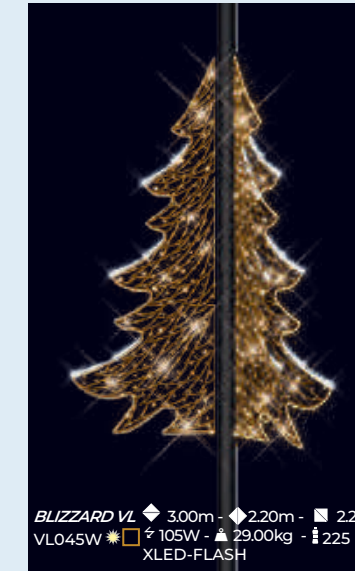

**BLIZZARD VL**  
VL045W \*\*\*□  
◆ 3.00m - ◆ 2.20m - 📏 2.20m  
⚡ 105W - ⚖ 29.00kg - 📏 225  
XLED-FLASH

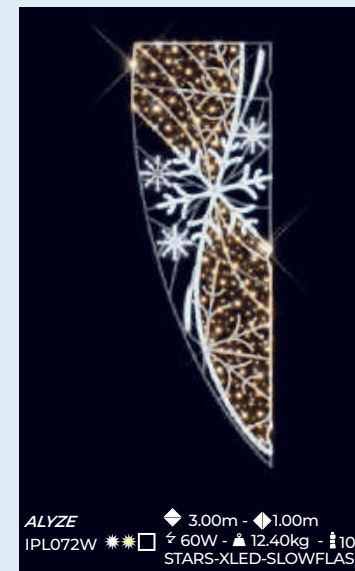

**ALYZE**  
IPL072W \*\*\*□  
◆ 3.00m - ◆ 1.00m  
⚡ 60W - ⚖ 12.40kg - 📏 102  
STARS-XLED-SLOWFLASH

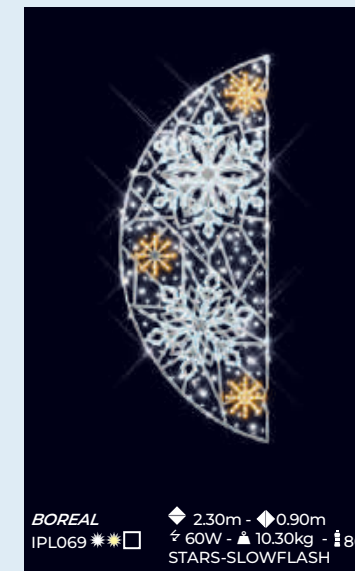

**BOREAL**  
IPL069 \*\*\*□  
◆ 2.30m - ◆ 0.90m  
⚡ 60W - ⚖ 10.30kg - 📏 86  
STARS-SLOWFLASH

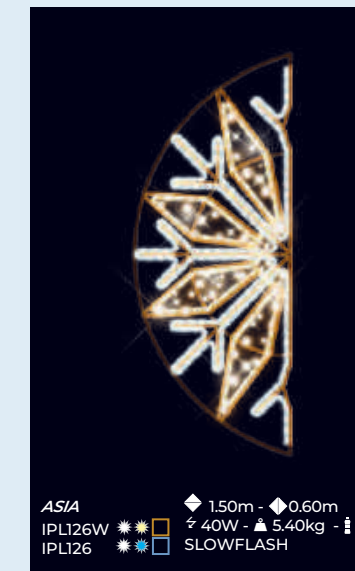

**ASIA**  
IPL126W \*\*\*□  
◆ 1.50m - ◆ 0.60m  
⚡ 40W - ⚖ 5.40kg - 📏 62  
IPL126 \*\*\*□  
SLOWFLASH

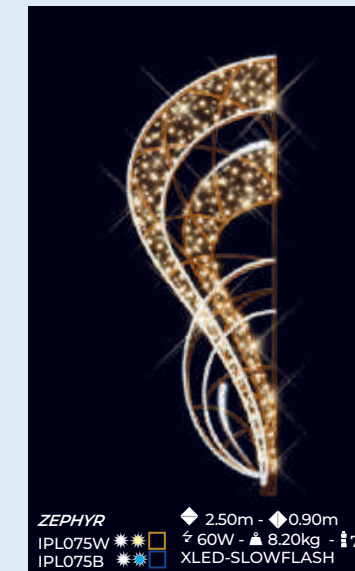

**ZEPHYR**  
IPL075W \*\*\*□  
◆ 2.50m - ◆ 0.90m  
⚡ 60W - ⚖ 8.20kg - 📏 76  
IPL075B \*\*\*□  
XLED-SLOWFLASH

# COLLECTION *MAGIC*

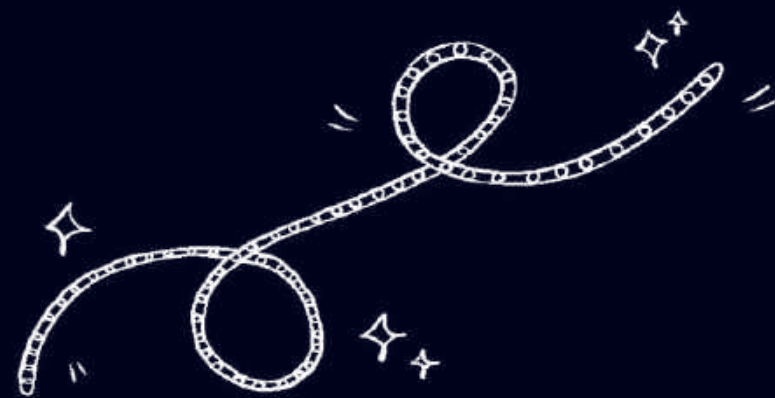



**ASTRAL JF**  
ITL234W \* \* \* □  
◆ 0.85m - ◆ 4.50m  
⚡ 100W - ⚖ 16.00kg - 📏 109  
STARS



**ASTRAL CHAIN**  
ITL227B \* \* \* □  
ITL227W \* \* \* □  
◆ 1.00m - ◆ 4.00m  
⚡ 65W - ⚖ 15.50kg - 📏 68  
STARS -FLASH



**ASTRAL CHAIN**  
ITL227W \* \* \* □  
ITL227B \* \* \* □  
◆ 1.00m - ◆ 4.00m  
⚡ 65W - ⚖ 11.90kg - 📏 68  
STARS -FLASH



**ASTRAL BANNER** ◆ 2.80m - ◆ 0.80m  
IPL190B \* \* \* □ ⚡ 55W - ⚖ 10.10kg - 📏 67  
IPL190W \* \* \* □ XLED-STARS-SLOWFLASH  
IPL190R \* \* \* □  
**TO ORDER**

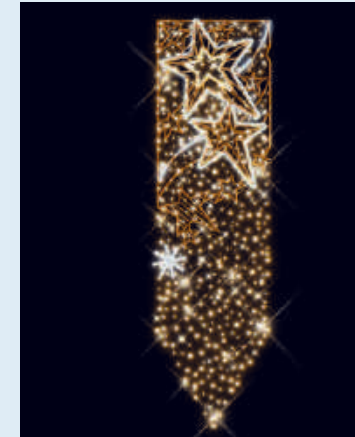

**ASTRAL BANNER** ◆ 2.80m - ◆ 0.80m  
IPL190W \* \* \* □ ⚡ 55W - ⚖ 10.10kg - 📏 67  
IPL190B \* \* \* □ SLOWFLASH-XLED-STARS  
IPL190R \* \* \* □

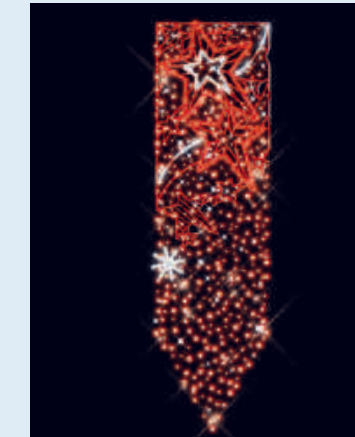

**ASTRAL BANNER** ◆ 2.80m - ◆ 0.80m  
IPL190R \* \* \* □ ⚡ 55W - ⚖ 10.10kg - 📏 67  
IPL190B \* \* \* □ FLASH-XLED-STARS  
IPL190W \* \* \* □

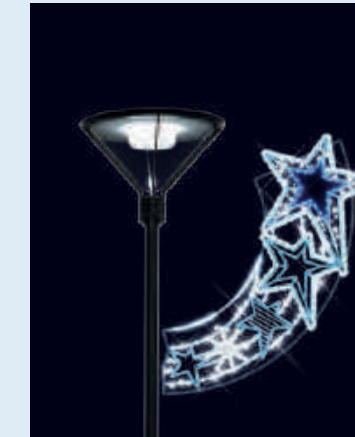

**ASTRAL ROLL** ◆ 1.30m - ◆ 1.10m  
IPL228B \* \* \* □ ⚡ 35W - ⚖ 6.00kg - 📏 51  
IPL228W \* \* \* □ STARS-XLED-SLOWFLASH

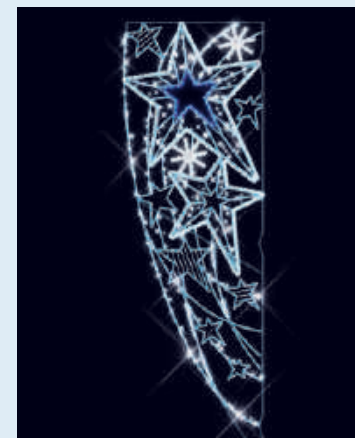

**ASTRAL DRAPEAU** ◆ 3.00m - ◆ 1.00m  
IPL189B \* \* \* □ ⚡ 65W - ⚖ 13.50kg - 📏 128  
IPL189W \* \* \* □ XLED-STARS-SLOWFLASH  
IPL189R \* \* \* □

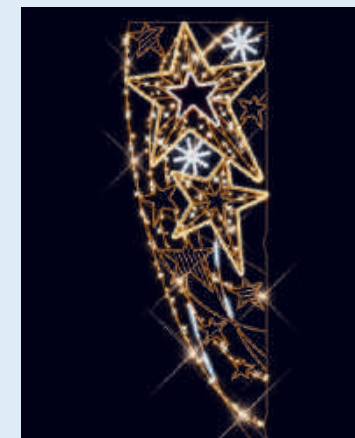

**ASTRAL DRAPEAU** ◆ 3.00m - ◆ 1.00m  
IPL189W \* \* \* □ ⚡ 65W - ⚖ 13.50kg - 📏 128  
IPL189R \* \* \* □ XLED - STARS-SLOWFLASH  
IPL189B \* \* \* □

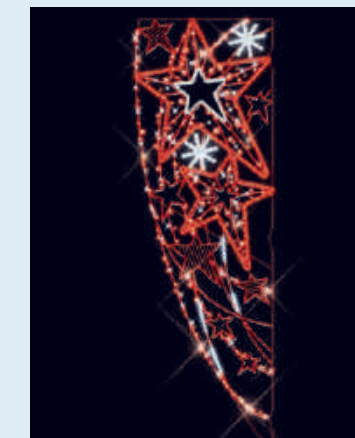

**ASTRAL DRAPEAU** ◆ 3.00m - ◆ 1.00m  
IPL189R \* \* \* □ ⚡ 65W - ⚖ 13.50kg - 📏 128  
IPL189B \* \* \* □ XLED - STARS-SLOWFLASH  
IPL189W \* \* \* □

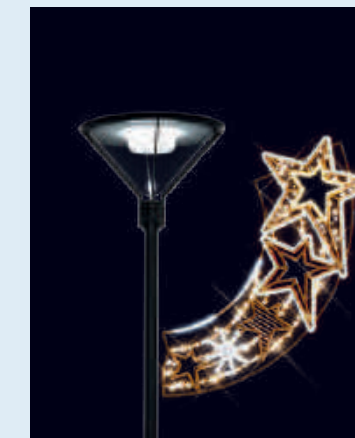

**ASTRAL ROLL** ◆ 1.30m - ◆ 1.10m  
IPL228W \* \* \* □ ⚡ 35W - ⚖ 6.00kg - 📏 51  
IPL228B \* \* \* □ STARS-XLED-SLOWFLASH





**GRANDE STELLA**  
ITL094W \* \* \* □  
◆ 1.20m - ◆ 6.00m  
⚡ 195W - ⚠ 26.40kg - ⚡ 250  
XLED-SLOWFLASH



**ASTRAL TRAVERSE**  
ITL191B \* \* \* □  
ITL191W \* \* \* □  
◆ 0.90m - ◆ 4.00m  
⚡ 120W - ⚠ 20.00kg - ⚡ 167  
STARS-XLED-SLOWFLASH

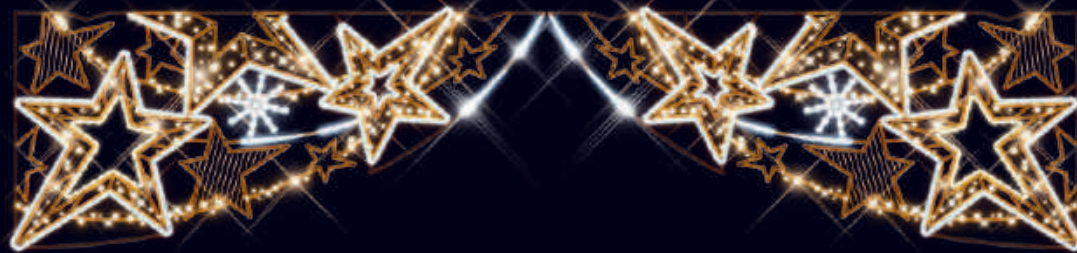

**ASTRAL TRAVERSE**  
ITL191W \* \* \* □  
ITL191B \* \* \* □  
◆ 0.90m - ◆ 4.00m  
⚡ 120W - ⚠ 20.00kg - ⚡ 167  
STARS-XLED-SLOWFLASH



**LIV CHAIN**  
ITL162W \* \* \* □  
◆ 1.24m - ◆ 6.00m  
⚡ 170W - ⚠ 27.00kg - ⚡ 13  
XLED-SLOWFLASH-FLASH

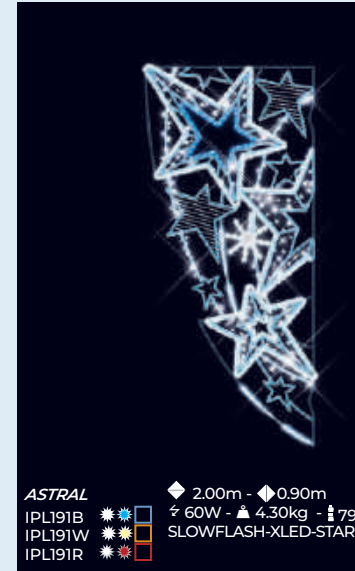

**ASTRAL**  
IPL191B \* \* \* □  
IPL191W \* \* \* □  
IPL191R \* \* \* □  
◆ 2.00m - ◆ 0.90m  
⚡ 60W - ⚠ 4.30kg - ⚡ 79  
SLOWFLASH-XLED-STARS

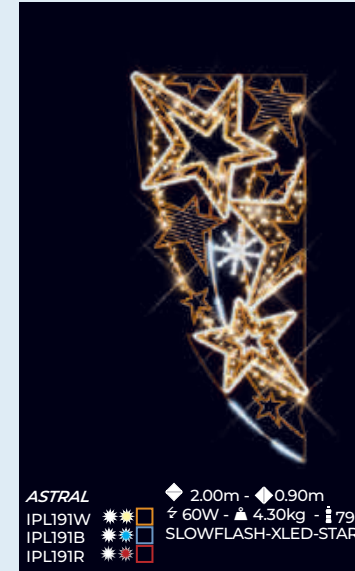

**ASTRAL**  
IPL191W \* \* \* □  
IPL191B \* \* \* □  
IPL191R \* \* \* □  
◆ 2.00m - ◆ 0.90m  
⚡ 60W - ⚠ 4.30kg - ⚡ 79  
SLOWFLASH-XLED-STARS

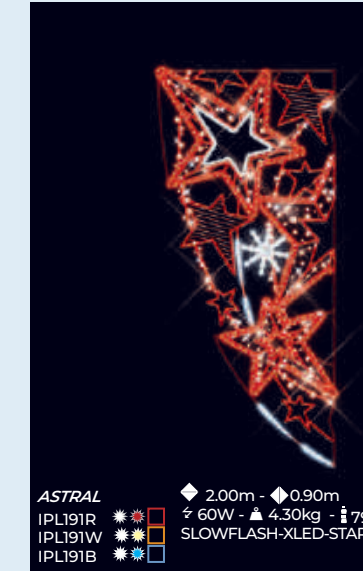

**ASTRAL**  
IPL191R \* \* \* □  
IPL191W \* \* \* □  
IPL191B \* \* \* □  
◆ 2.00m - ◆ 0.90m  
⚡ 60W - ⚠ 4.30kg - ⚡ 79  
SLOWFLASH-XLED-STARS



**LEIA XMAS**  
ITL109W \* \* \* □  
◆ 1.12m - ◆ 1.12m  
⚡ 35W - ⚠ 4.90kg - ⚡ 37  
SLOWFLASH



**CELESTE**  
IPL042W \* \* \* □  
◆ 3.00m - ◆ 0.85m  
⚡ 75W - ⚠ 10.00kg - ⚡ 92  
FLASH

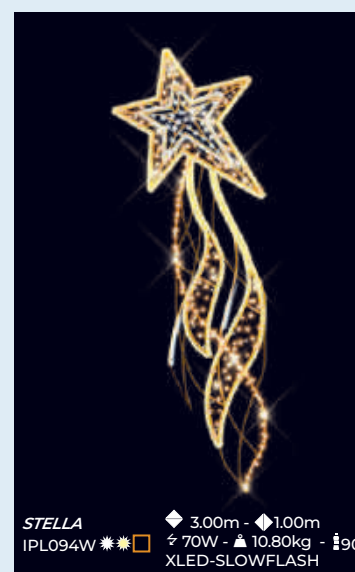

**STELLA**  
IPL094W \* \* \* □  
◆ 3.00m - ◆ 1.00m  
⚡ 70W - ⚠ 10.80kg - ⚡ 90  
XLED-SLOWFLASH

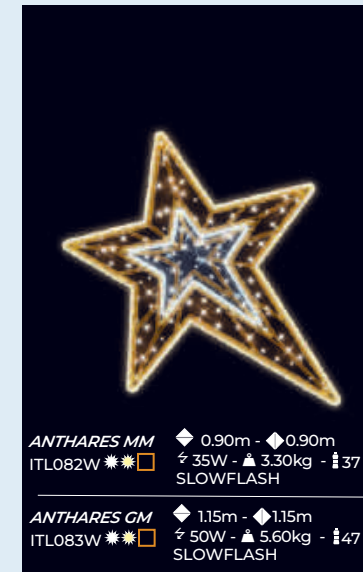

**ANTHARES MM**  
ITL082W \* \* \* □  
◆ 0.90m - ◆ 0.90m  
⚡ 35W - ⚠ 3.30kg - ⚡ 37  
SLOWFLASH

**ANTHARES GM**  
ITL083W \* \* \* □  
◆ 1.15m - ◆ 1.15m  
⚡ 50W - ⚠ 5.60kg - ⚡ 47  
SLOWFLASH

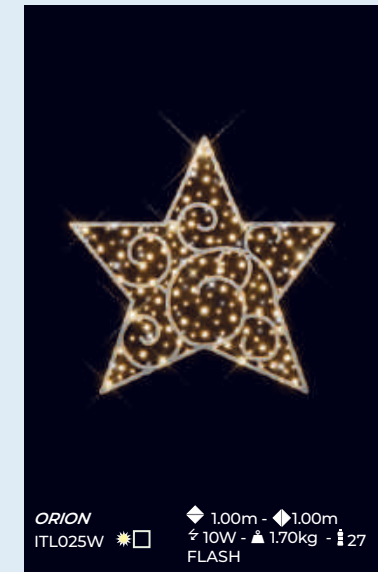

**ORION**  
ITL025W \* \* \* □  
◆ 1.00m - ◆ 1.00m  
⚡ 10W - ⚠ 1.70kg - ⚡ 27  
FLASH



Easily transform any hanging decoration into a polemount decoration, thanks to our accessory: PIX01 (see p256)



**N** *CLEO*  
TL311R ✨  
◆ 2.10m - ◆ 1.81m - ■ 0.51m  
⚡ 18W - ▲ 21.00kg - 📏 94  
FLASH

TO ORDER

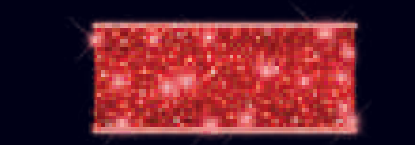

**N** *CLEO RUBAN*  
TL312R ✨  
◆ 0.80m - ◆ 2.00m  
⚡ 45W - ▲ 8.00kg  
FLASH

TO ORDER

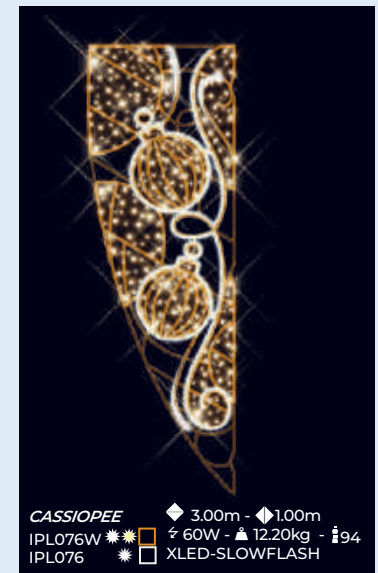

*CASSIOPEE*  
IPL076W ✨ ✨  
IPL076 ✨  
◆ 3.00m - ◆ 1.00m  
⚡ 60W - ▲ 12.20kg - 📏 94  
XLED-SLOWFLASH

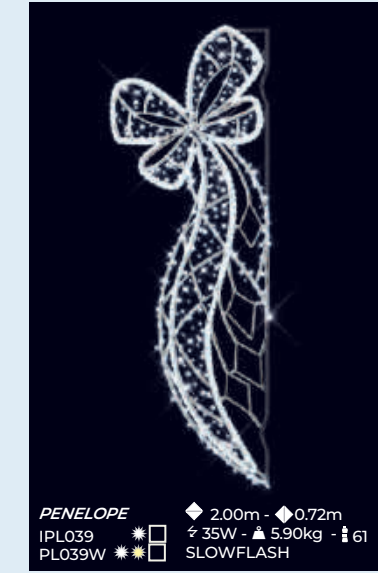

*PENELOPE*  
IPL039 ✨  
PL039W ✨ ✨  
◆ 2.00m - ◆ 0.72m  
⚡ 35W - ▲ 5.90kg - 📏 61  
SLOWFLASH

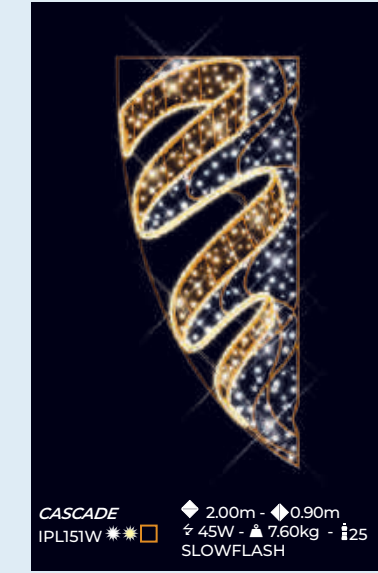

*CASCADE*  
IPL151W ✨ ✨  
◆ 2.00m - ◆ 0.90m  
⚡ 45W - ▲ 7.60kg - 📏 25  
SLOWFLASH

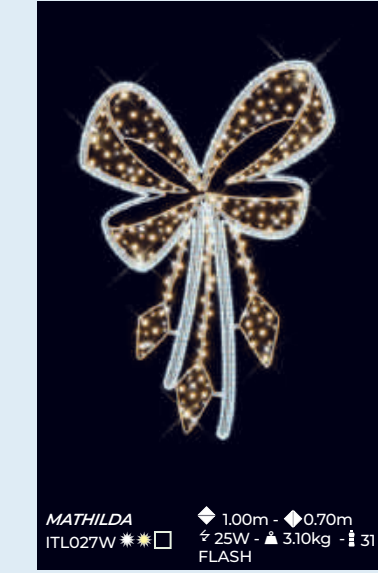

*MATHILDA*  
ITL027W ✨ ✨  
◆ 1.00m - ◆ 0.70m  
⚡ 25W - ▲ 3.10kg - 📏 31  
FLASH

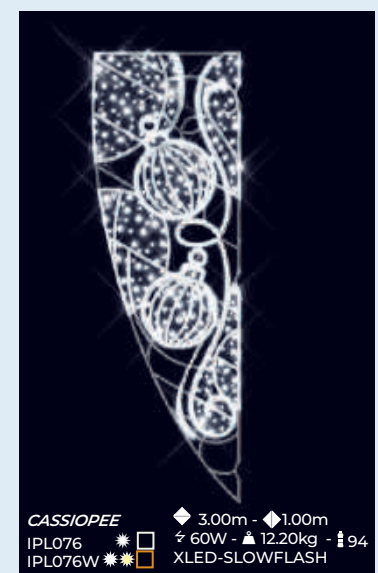

*CASSIOPEE*  
IPL076 ✨  
IPL076W ✨ ✨  
◆ 3.00m - ◆ 1.00m  
⚡ 60W - ▲ 12.20kg - 📏 94  
XLED-SLOWFLASH

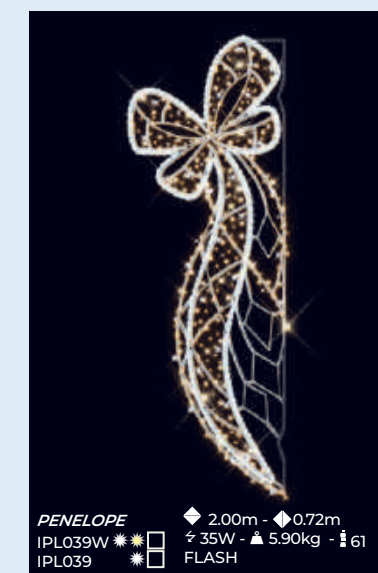

*PENELOPE*  
IPL039W ✨ ✨ ✨  
IPL039 ✨ ✨  
◆ 2.00m - ◆ 0.72m  
⚡ 35W - ▲ 5.90kg - 📏 61  
FLASH

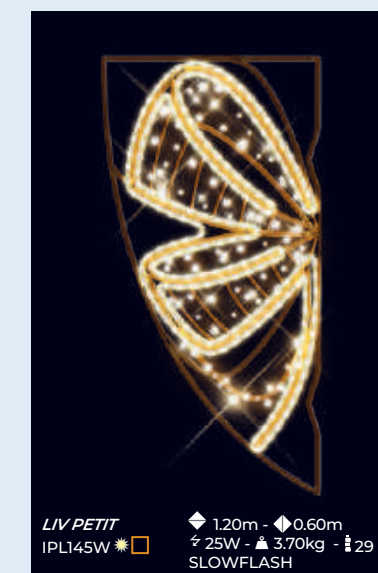

*LIV PETIT*  
IPL145W ✨ ✨  
◆ 1.20m - ◆ 0.60m  
⚡ 25W - ▲ 3.70kg - 📏 29  
SLOWFLASH

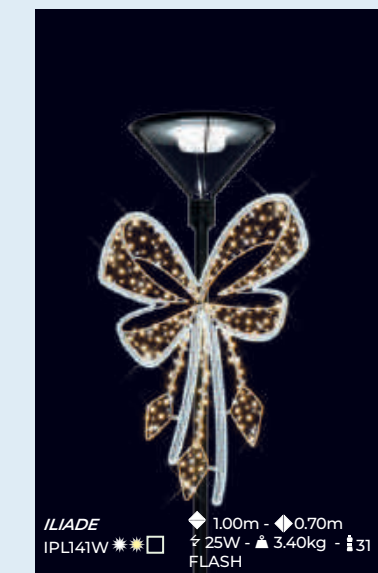

*ILIADE*  
IPL141W ✨ ✨ ✨ ✨  
◆ 1.00m - ◆ 0.70m  
⚡ 25W - ▲ 3.40kg - 📏 31  
FLASH



Combination of TL311W and several TL312W.

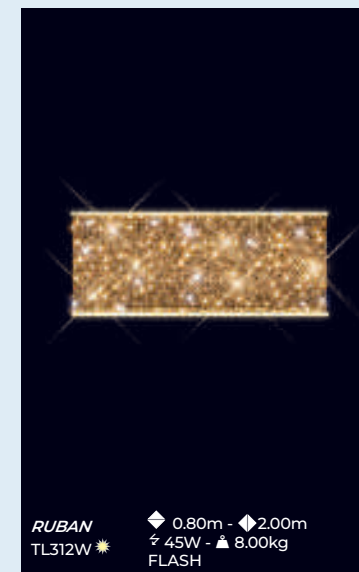
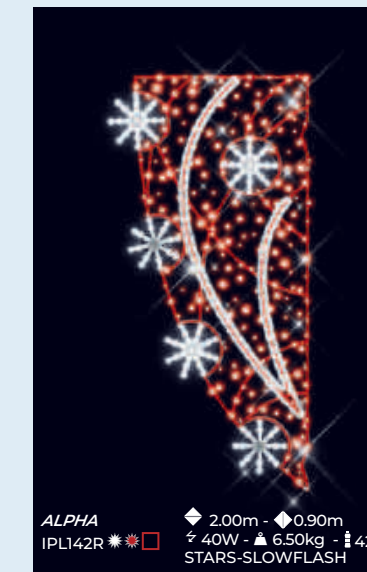
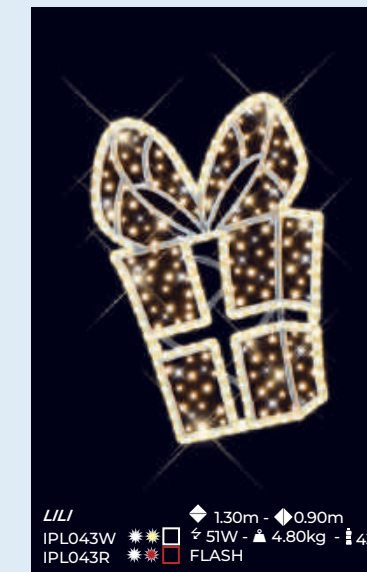
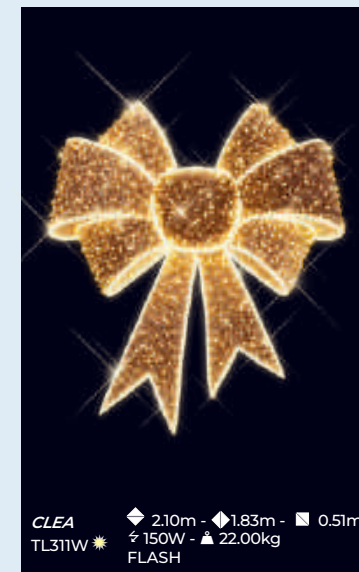

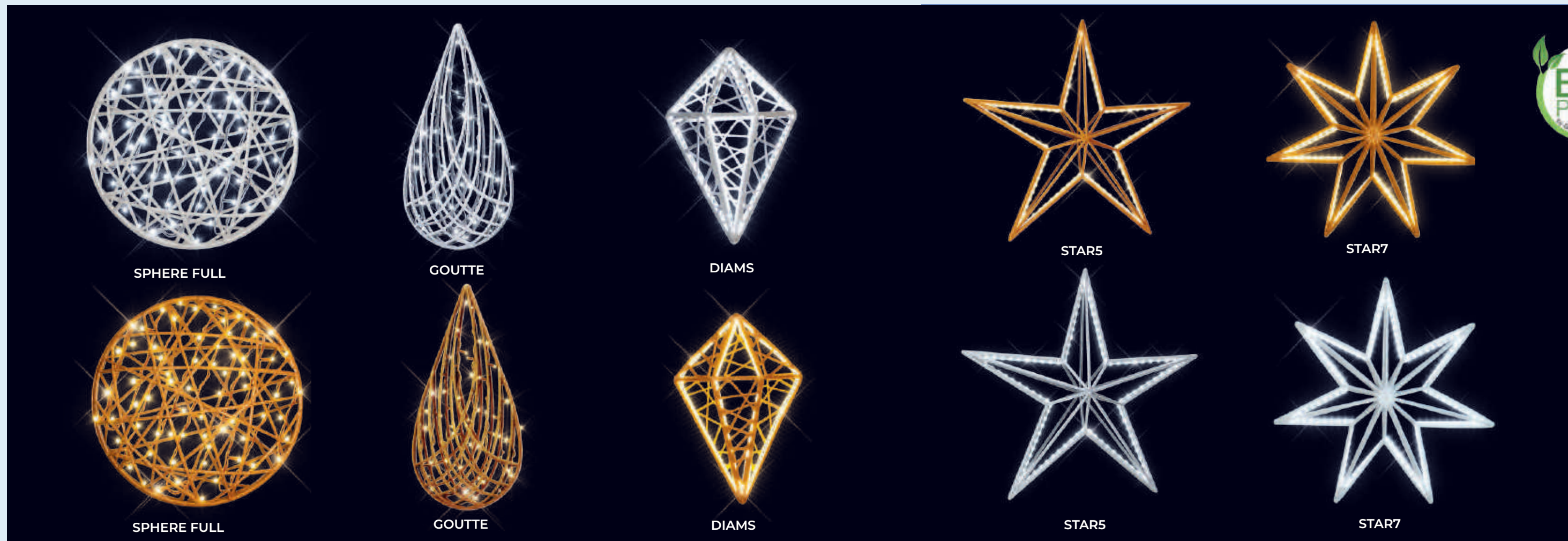

Schematic diagram of all the lights presented on this double page:

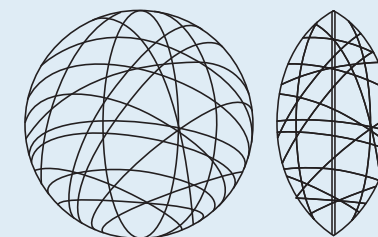

Front view

Side view

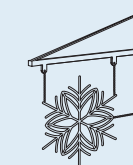

Easily transform any hanging decoration into a polemount decoration, thanks to our accessory: PIX01 (see p256)

Référence	Description	Colour	Height	Width	Depth	P(W)	Weight
ITGL104	sphere full	○	0.50m	0.50m	0.26m	10W	1.70kg
ITGL104W	sphere full	●	0.50m	0.50m	0.26m	10W	1.70kg
ITGL105	sphere full	○	0.80m	0.80m	0.4m	20W	3.20kg
ITGL105W	sphere full	●	0.80m	0.80m	0.4m	20W	3.20kg
ITGL131	goutte	○	0.80m	0.40m	0.26m	10W	1.80kg
ITGL131W	goutte	●	0.80m	0.40m	0.26m	10W	1.80kg
ITGL102	diams	○	0.60m	0.40m	0.24m	15W	1.50kg
ITGL102W	diams	●	0.60m	0.40m	0.24m	15W	1.50kg

Référence	Description	Colour	Height	Width	Depth	P(W)	Weight
ITGL112	star5	○	0.80m	0.80m	0.18m	8W	1.50kg
ITGL112W	star5	●	0.80m	0.80m	0.18m	8W	1.50kg
ITGL111	star7	○	0.80m	0.80m	0.18m	15W	1.90kg
ITGL111W	star7	●	0.80m	0.80m	0.18m	15W	1.90kg



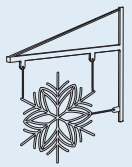

Easily transform any hanging decoration into a polemount decoration, thanks to our accessory: PIX01 (see p256)



LOVE



ALTO

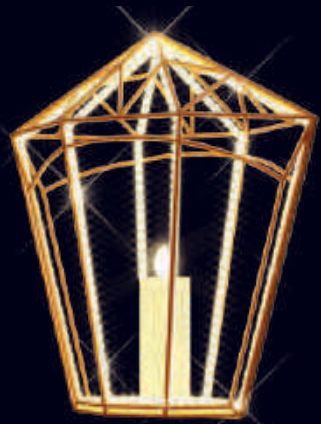

LANTERNA



Référence	Description	Colour	Height	Width	Depth	P(W)	Weight
ITGL117R	love	●	0.60m	0.60m	0.46m	8W	2.00kg
ITGL130W	lanterna	●	0.70m	0.70m	0.40m	26W	5.00kg
ITGL141	alto	●	1.00m	1.00m	0.40m	35W	5.10kg

3D

3D foldable spheres  
(for optimized storage)

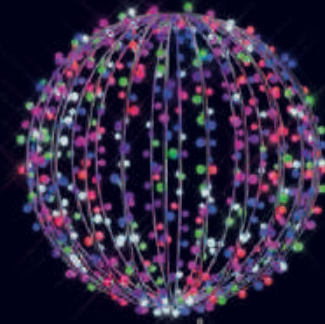

N



∅ 0,60m  
● TGL70LWW  
sphere pliable pm  
◆ 0,60m - ◆ 0,60m - ■ 0,60m  
⚡ 30W - ☒ 3.9kg  
● TGL70LW

∅ 1,00m  
RGB TGL71LWCL  
sphere pliable mm  
◆ 1,00m - ◆ 1,00m - ■ 1,00m  
⚡ 8W - ☒ 15.0kg  
● TGL71LW

∅ 1,60m  
● TGL71LWW  
● TGL72LWW  
sphere pliable gm  
◆ 1,60m - ◆ 1,60m - ■ 1,60m  
⚡ 165W - ☒ 24,8kg  
● TGL72LW

2D

2D Spheres



∅ 0,30m  
● ITL051W  
sphere pm  
◆ 0,30m - ◆ 0,80m  
⚡ 5W - ☒ 1,0kg  
● ITL051 - ● ITL051B - ● ITL051R

∅ 0,60m  
● ITL052W  
sphere mm  
◆ 0,60m - ◆ 0,60m  
⚡ 10W - ☒ 1,7kg  
● ITL052 - ● ITL052B - ● ITL052R

∅ 1,00m  
● ITL053W  
sphere gm  
◆ 1,00m - ◆ 1,00m  
⚡ 20W - ☒ 2.8kg  
● ITL053 - ● ITL053B - ● ITL053R

# COLLECTION COSY





**N**  
**COSY UNIT**  
 ITL275R \* \* \* □ □  
 + 2x GP303W  
 ◆ 1.00m - ◆ 0.80m  
 ⚡ 14W - ▲ 5.00kg - ⚡ 40  
 SLOWFLASH



**N**  
**COSY TREE UNIT**  
 ITL278W \* □ □ □  
 + 2x GP303W  
 ◆ 0.95m - ◆ 0.63m  
 ⚡ 18W - ▲ 5.00kg - ⚡ 55  
 SLOWFLASH



**N**  
**COSY STAR UNIT**  
 ITL276R \* \* \* □ □  
 + 2x GP303W  
 ◆ 0.95m - ◆ 0.85m  
 ⚡ 14W - ▲ 5.00kg - ⚡ 38  
 SLOWFLASH

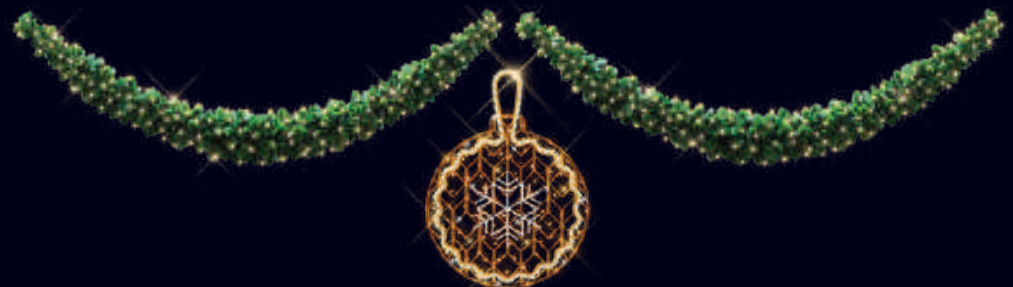

**N**  
**COSY BALL UNIT**  
 ITL279W \* □ □ □  
 + 2x GP303W  
 ◆ 1.00m - ◆ 0.75m  
 ⚡ 18W - ▲ 6.00kg - ⚡ 40  
 SLOWFLASH



**N**  
**COSY STAR UNIT**  
 ITL276W \* □ □  
 ITL276R \* \* \* □ □  
 ◆ 0.95m - ◆ 0.85m  
 ⚡ 14W - ▲ 5.00kg - ⚡ 38  
 SLOWFLASH

**N**  
**COSY BALL UNIT**  
 ITL279R \* □ □ □  
 ITL279W \* □ □ □  
 ◆ 0.95m - ◆ 0.78m  
 ⚡ 18W - ▲ 6.00kg - ⚡ 80  
 SLOWFLASH

**N**  
**COSY ANGEL UNIT**  
 ITL277W \* □ □  
 ◆ 0.95m - ◆ 0.85m  
 ⚡ 14W - ▲ 5.00kg - ⚡ 38  
 SLOWFLASH

**LUCIA**  
 ITL084W \* □ □ □  
 ◆ 0.85m - ◆ 0.70m  
 ⚡ 20W - ▲ 2.20kg - ⚡ 23  
 SLOWFLASH



**N**  
**COSY PETIT**  
 IPL271R \* □ □ □  
 IPL271W \* □ □ □  
 ◆ 1.50m - ◆ 0.60m  
 ⚡ 22W - ▲ 5.00kg - ⚡ 28  
 SLOWFLASH

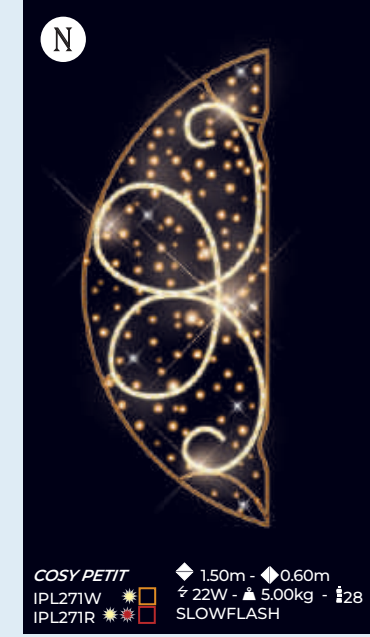

**N**  
**COSY PETIT**  
 IPL271W \* □ □ □  
 IPL271R \* □ □ □  
 ◆ 1.50m - ◆ 0.60m  
 ⚡ 22W - ▲ 5.00kg - ⚡ 28  
 SLOWFLASH

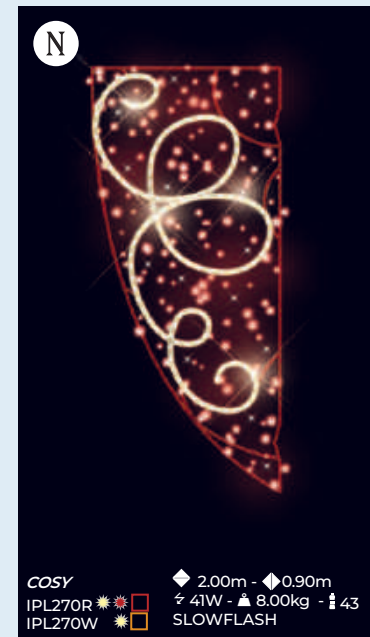

**N**  
**COSY**  
 IPL270R \* \* \* □ □ □  
 IPL270W \* \* \* □ □ □  
 ◆ 2.00m - ◆ 0.90m  
 ⚡ 41W - ▲ 8.00kg - ⚡ 43  
 SLOWFLASH

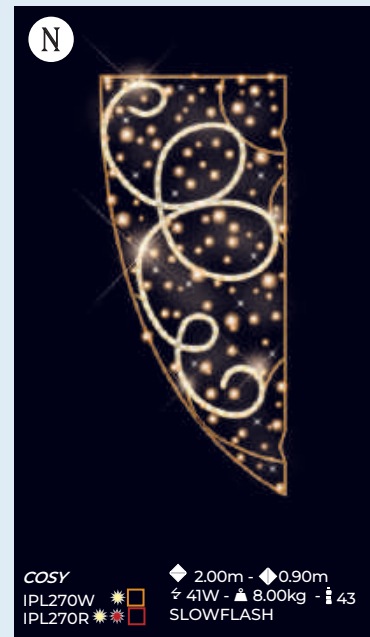

**N**  
**COSY**  
 IPL270W \* □ □ □  
 IPL270R \* \* \* □ □ □  
 ◆ 2.00m - ◆ 0.90m  
 ⚡ 41W - ▲ 8.00kg - ⚡ 43  
 SLOWFLASH



**N**  
**GRACE DOUBLE**  
 ITL266W \* □  
 ◆ 0.90m - ◆ 4.00m  
 ⚡ 105W - ▲ 17.00kg - ⚡ 128  
 SLOWFLASH-XLED



**CALYPSO DOUBLE**  
 ITL113W \* □  
 ◆ 0.85m - ◆ 4.00m  
 ⚡ 110W - ▲ 15.10kg - ⚡ 82  
 SLOWFLASH



**ILWAN**  
 ITL165W \* □  
 ◆ 1.00m - ◆ 3.00m  
 ⚡ 105W - ▲ 15.30kg - ⚡ 141  
 XLED-SLOWFLASH

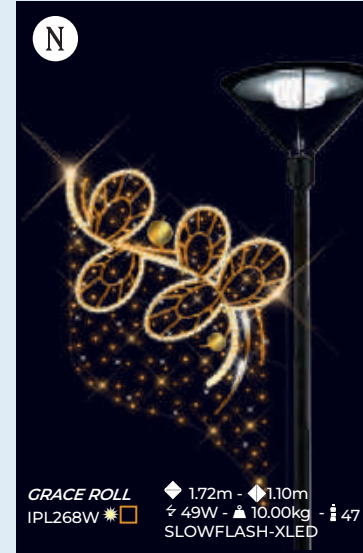

**N**  
**GRACE ROLL**  
 IPL268W \* □  
 ◆ 1.72m - ◆ 1.10m  
 ⚡ 49W - ▲ 10.00kg - ⚡ 47  
 SLOWFLASH-XLED

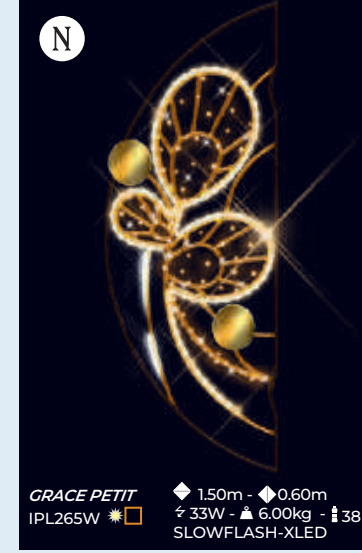

**N**  
**GRACE PETIT**  
 IPL265W \* □  
 ◆ 1.50m - ◆ 0.60m  
 ⚡ 33W - ▲ 6.00kg - ⚡ 38  
 SLOWFLASH-XLED



**N**  
**GRACE PETIT**  
 IPL266W \* □  
 ◆ 2.00m - ◆ 0.90m  
 ⚡ 53W - ▲ 9.00kg - ⚡ 64  
 SLOWFLASH-XLED

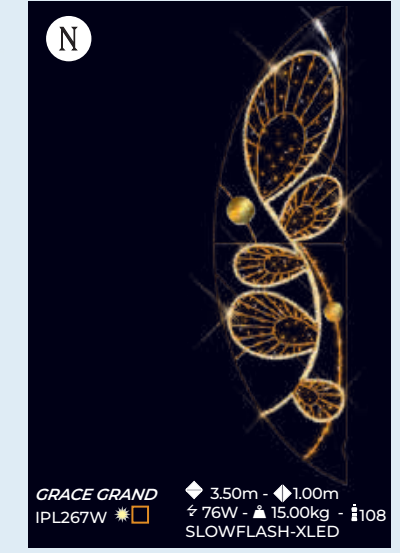

**N**  
**GRACE GRAND**  
 IPL267W \* □  
 ◆ 3.50m - ◆ 1.00m  
 ⚡ 76W - ▲ 15.00kg - ⚡ 108  
 SLOWFLASH-XLED

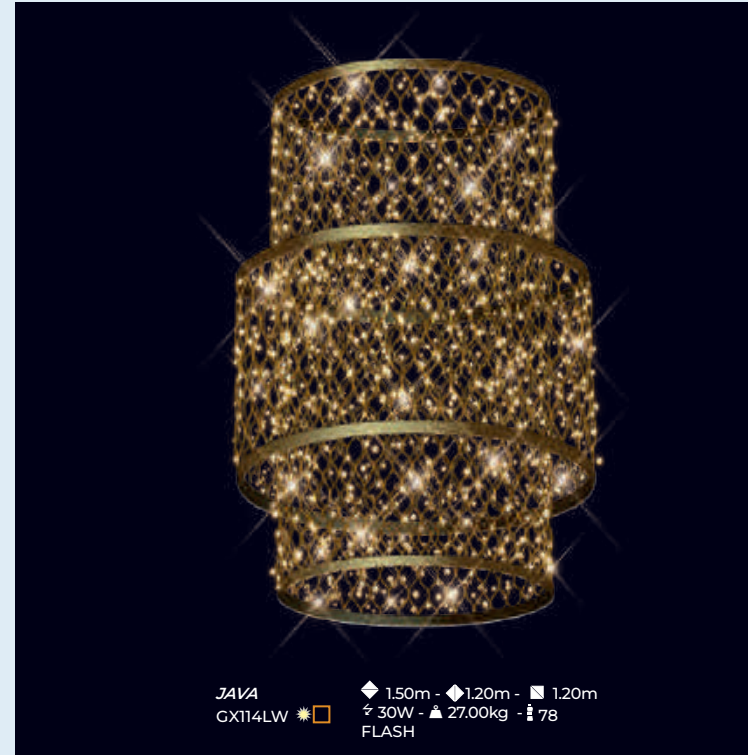

**JAVA**  
 GX114LW \* □  
 ◆ 1.50m - ◆ 1.20m - ■ 1.20m  
 ⚡ 30W - ▲ 27.00kg - ⚡ 78  
 FLASH

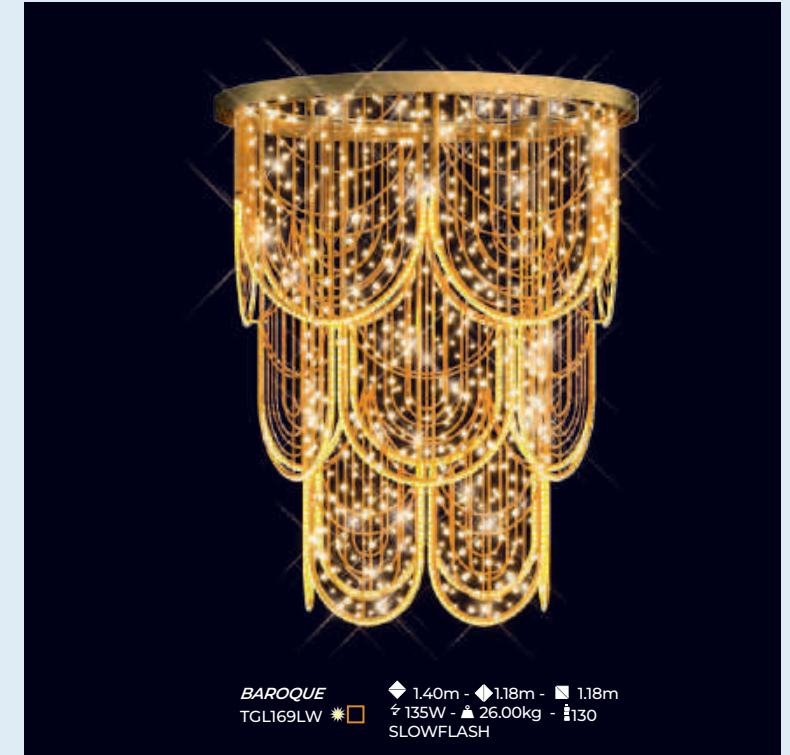

**BAROQUE**  
 TGL169LW \* □  
 ◆ 1.40m - ◆ 1.18m - ■ 1.18m  
 ⚡ 135W - ▲ 26.00kg - ⚡ 130  
 SLOWFLASH





**ULYSSE**  
CX117LW \* □  
◆ 2.00m - ◆ 1.50m - ■ 1.50m  
⚡ 130W - ⚖ 25.60kg - 📏 11  
SLOWFLASH



**ACHILLE**  
GX116LW \*  
◆ 0.70m - ◆ 0.60m  
⚡ 15W - ⚖ 3.60kg  
SLOWFLASH



**AURORA**  
CX048LW \*  
◆ 0.73m - ◆ 0.48m - ■ 0.48m  
⚡ 40W - ⚖ 4.30kg



**LUZ**  
TGL247LW \*  
◆ 0.36m - ◆ 0.26m - ■ 0.26m  
⚡ 5W - ⚖ 1.30kg

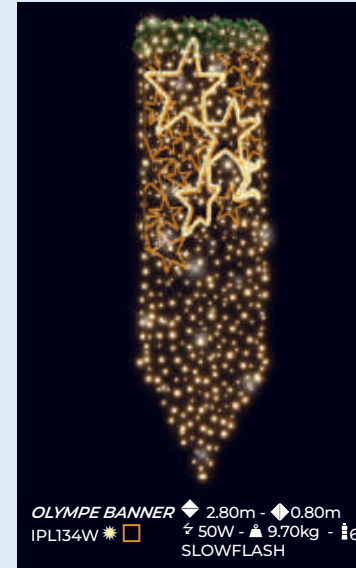

**OLYMPIE BANNER**  
IPL134W \* □  
◆ 2.80m - ◆ 0.80m  
⚡ 50W - ⚖ 9.70kg - 📏 63  
SLOWFLASH

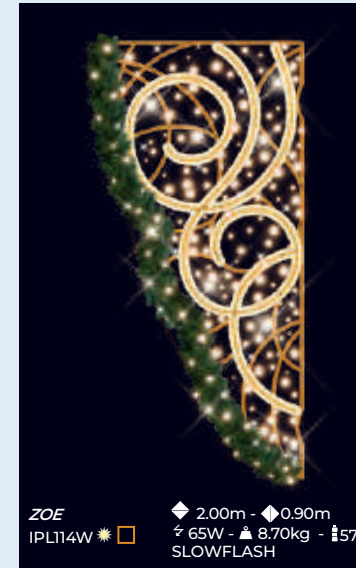

**ZOE**  
IPL114W \* □  
◆ 2.00m - ◆ 0.90m  
⚡ 65W - ⚖ 8.70kg - 📏 57  
SLOWFLASH

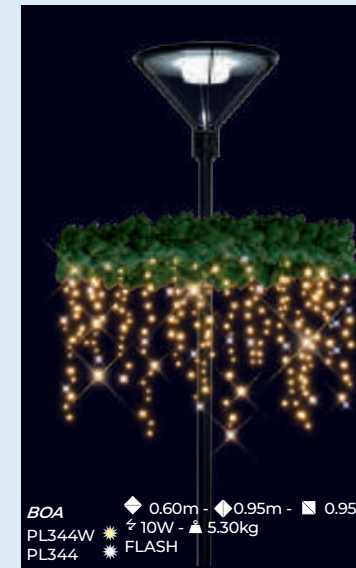

**BOA**  
PL344W \*  
PL344 \*  
◆ 0.60m - ◆ 0.95m - ■ 0.95m  
⚡ 10W - ⚖ 5.30kg  
FLASH

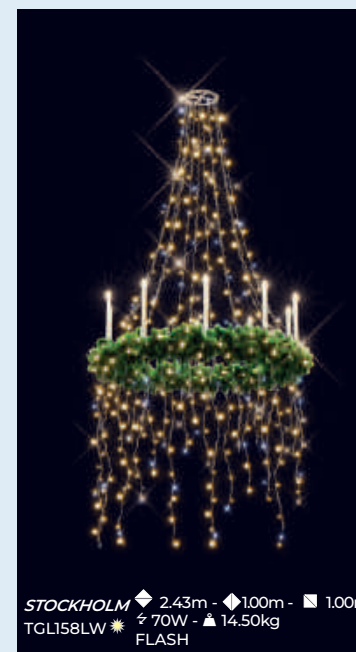

**STOCKHOLM**  
TGL158LW \*  
◆ 2.43m - ◆ 1.00m - ■ 1.00m  
⚡ 70W - ⚖ 14.50kg  
FLASH

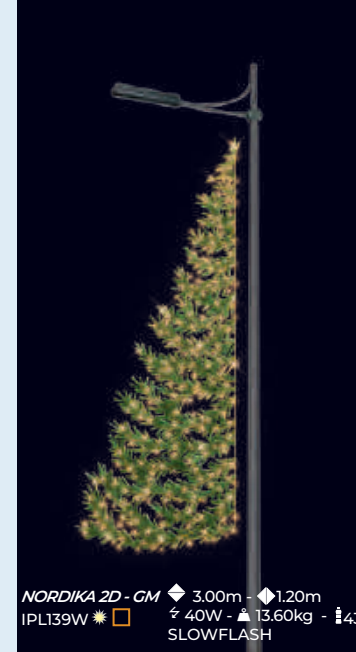

**NORDIKA 2D - GM**  
IPL139W \* □  
◆ 3.00m - ◆ 1.20m  
⚡ 40W - ⚖ 13.60kg - 📏 43  
SLOWFLASH

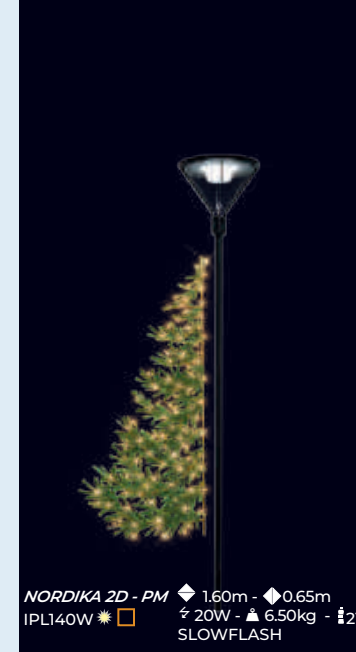

**NORDIKA 2D - PM**  
IPL140W \* □  
◆ 1.60m - ◆ 0.65m  
⚡ 20W - ⚖ 6.50kg - 📏 21  
SLOWFLASH



# SOLAR RANGE

Varied decorations that adapt to all your decoration themes and work with solar energy

**N**



**STARS S.**  
IPS289W \* □  
◆ 1.20m - ◆ 0.60m  
⚡ 8W - ⚙ 4.00kg - ⏱ 30  
FLASH-STARS

TO ORDER

**N**

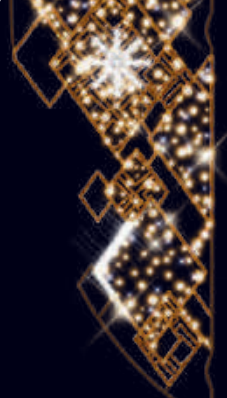

**QUADRILLES S.**  
IPS280W \* □  
◆ 2.00m - ◆ 0.90m  
⚡ 11W - ⚙ 7.00kg - ⏱ 57  
FLASH-XLED-STARS

TO ORDER

**N**



**QUADRILLES S.**  
IPS280 \* □  
◆ 2.00m - ◆ 0.90m  
⚡ 11W - ⚙ 7.00kg - ⏱ 57  
FLASH-XLED-STARS

TO ORDER



**N**



**RIBBON S.**  
IPS290 \* □  
◆ 1.80m - ◆ 0.43m  
⚡ 10W - ⚙ 5.00kg - ⏱ 38  
FLASH-XLED

TO ORDER

**N**



**BLIZZY S.**  
IPS264W \* □  
◆ 1.20m - ◆ 0.50m  
⚡ 4W - ⚙ 3.00kg - ⏱ 28  
FLASH-STARS

TO ORDER

**N**

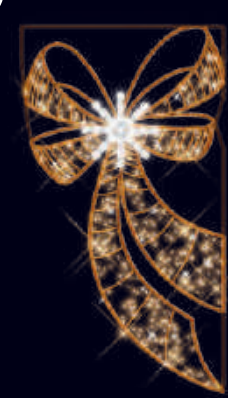

**RIBBON S.**  
IPS281W \* □  
◆ 1.20m - ◆ 0.60m  
⚡ 7W - ⚙ 4.00kg - ⏱ 28  
FLASH-STARS

TO ORDER

These decorations are equipped only with 24V LED garlands.

100% autonomous

Thanks to our new solar-powered rechargeable battery, you can combine lighting with energy efficiency.

Once your decor is in place, position the solar box on top of it facing the right way, set your switch-on and switch-off times and enjoy your lighted decorations.

Technical details:

- 8 to 10 hours of recharging with optimal sunlight for 7 hours of lighting.
- Your lights can be programmed to operate for 5, 6 or 7 hours.

Enter decor reference no. + PIXSOL2

## PIXSOL2

20W panel power  
7,2W power output

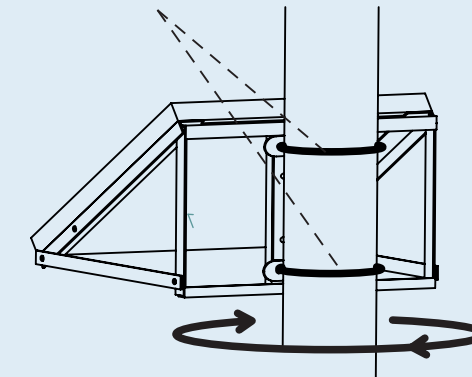

When you set it up, make sure it is facing the right way to get the most sun during the day

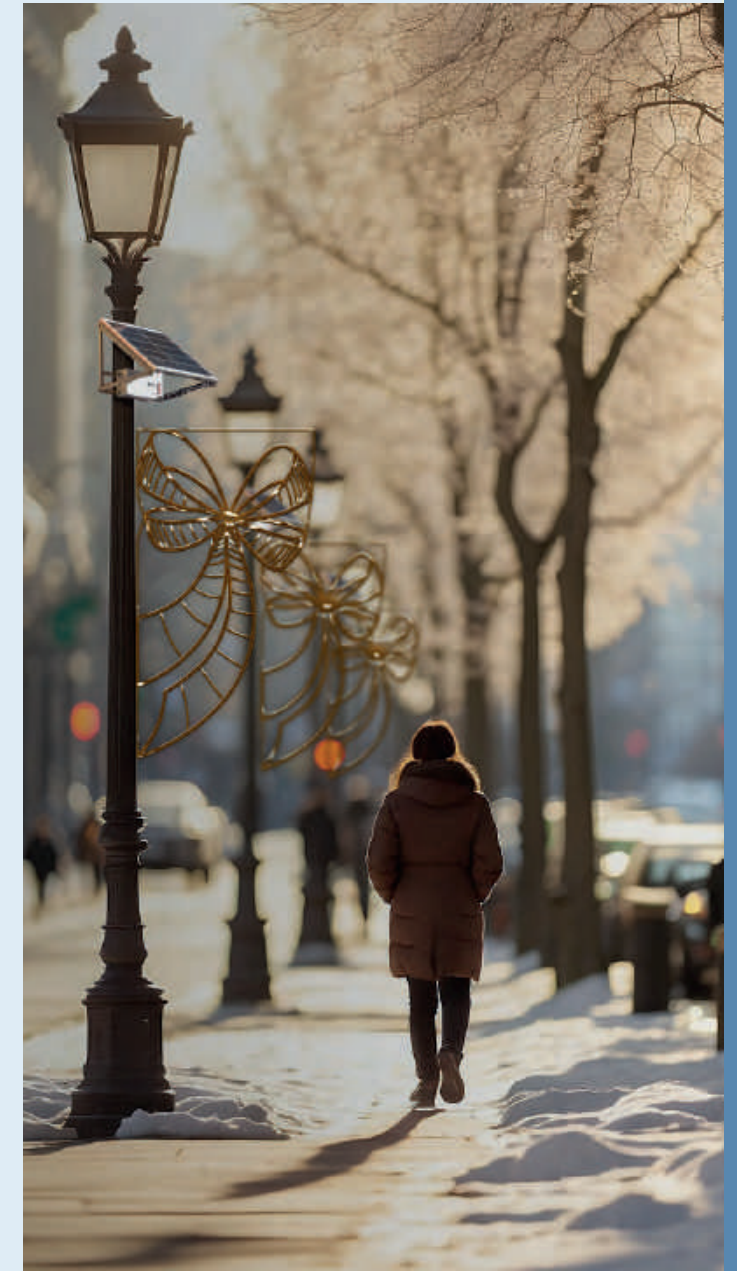

# 3D CHARACTERS



**N** LULU  
GX200L

◆ 1,60m - ◆ 1,41m - ▣ 0,67m  
⚡ 16W - ▲ 38,00kg  
FLASH

BLIZZARD PHOTOBOOTH  
SOCL42

◆ 2,20m - ◆ 1,60m - ▣ 0,80m  
⚡ 25W - ▲ 18,50kg - 📏 142

FROZEN LETTERBOX  
GX149L

◆ 2,00m - ◆ 1,10m - ▣ 1,10m  
⚡ 49W - ▲ 36,00kg - 📏 432  
STARS-FLASH



**GARY** GX250L-A  
 ◆ 2.30m - ◆ 2.14m - ■ 1.00m  
 ⚡ 46W - ▲ 71.00kg

With presence detector

**NOAH** GX145L  
 ◆ 3.00m - ◆ 2.27m - ■ 1.84m  
 ⚡ 54W - ▲ 76.00kg - 📶 21  
 XLED

**NOAH ANIME** GX145L-A  
 ◆ 3.00m - ◆ 2.27m - ■ 1.84m  
 ⚡ 54W - ▲ 100.00kg - 📶 21

+ buzzer

TO ORDER



**SKATE BEAR** GX047L  
 ◆ 2.30m - ◆ 1.95m - ■ 1.10m  
 ⚡ 30W - ▲ 44.00kg

**ICE IGLOO** GX079L  
 ◆ 1.50m - ◆ 2.20m - ■ 2.00m  
 ⚡ 64W - ▲ 55.00kg - 📶 134  
 FLASH

**PINGU** GX160L  
 ◆ 2.08m - ◆ 1.94m - ■ 1.16m  
 ⚡ 20W - ▲ 31.00kgH





**ELIOTT**  
GX163L  
◆ 2.80m - ◆ 2.02m - ■ 1.25m  
⚡ 20W - ▲ 32.00kg  
FLASH

**FOX**  
GX147L  
◆ 2.20m - ◆ 1.75m - ■ 1.40m  
⚡ 20W - ▲ 37.00kg  
FLASH



**BABY BEAR** ◆ 1.50m - ◆ 1.40m - ■ 1.30m  
GX206L ⚡ 40W - ▲ 30.40kg

**WIZZ SANTA** ◆ 2.30m - ◆ 3.80m - ■ 1.20m  
GX164L ⚡ 25W - ▲ 66.00kg  
FLASH

**DADDY BEAR** ◆ 1.50m - ◆ 2.20m - ■ 0.70m  
GX205L ⚡ 22W - ▲ 27.00kg

**RAYMOND** ◆ 2.20m - ◆ 1.50m - ■ 0.84m  
GX249L-A ⚡ 34W - ▲ 71.00kg  
With push button

**RAYMOND** ◆ 2.20m - ◆ 1.50m - ■ 0.84m  
GX249L ⚡ 34W - ▲ 55.00kg





**WELCOME**  
GX042L  
◆ 2.20m - ◆ 1.20m - ■ 0.80m  
⚡ 14W - ▲ 22.00kg - ⚡ 29  
FLASH

**DOUDOU**  
GX159L  
◆ 2.10m - ◆ 1.94m - ■ 1.19m  
⚡ 28W - ▲ 39.50kg  
FLASH

**N LOLLIPOP**  
GX265LW  
FLASH  
◆ 2.00m - ◆ 1.28m - ■ 1.28m  
⚡ 67W - ▲ 28.00kg



**N YUMMY**  
GX262LW  
◆ 1.60m - ◆ 1.30m - ■ 0.30m  
⚡ 36W - ▲ 24.00kg - ⚡ 346  
FLASH

**N MANALA**  
GX245LW  
◆ 1.88m - ◆ 1.34m - ■ 0.30m  
⚡ 56W - ▲ 29.00kg - ⚡ 258  
FLASH

**N TRADI PHOTOBOOTH**  
SOCL47  
◆ 3.75m - ◆ 4.93m - ■ 1.00m  
⚡ 60W - ▲ 81.50kg - ⚡ 205  
FLASH





**ASTRAL BOOTH**  
SOCL43  
◆ 2.20m - ◆ 2.00m - ■ 0.80m  
⚡ 25W - ▲ 20.40kg - 📏 118

**RENNOO**  
GX093L  
◆ 2.00m - ◆ 1.20m - ■ 0.60m  
⚡ 18W - ▲ 52.00kg  
FLASH

**CUTE RENNOO**  
GX092L  
◆ 2.20m - ◆ 1.15m - ■ 0.70m  
⚡ 18W - ▲ 99.00kg  
FLASH

**ELY**  
GX260LW  
◆ 1.60m - ◆ 1.24m - ■ 1.00m  
⚡ 20W - ▲ 12.00kg - 📏 67  
STARS

**2 in 1 products!**

You can choose from a warm white or pure white. By reversing the connectors, you can obtain either a pure white decor/ pure white flash or a warm white decor/warm white flash.



**WIZZ**  
CX194L  
◆ 1.20m - ◆ 2.30m - ■ 1.20m  
⚡ 79W - ▲ 82.00kg - 📏 277  
XLED-STARS-FLASH

**DUO COMETE**  
GX118DC  
◆ 2.60m - ◆ 2.18m - ■ 1.20m  
⚡ 42W - ▲ 27.40kg  
FLASH

**VERDE**  
SL045V  
◆ 2.45m - ◆ 1.75m - ■ 0.80m  
⚡ 180W - ▲ 45.50kg - 📏 299  
XLED





**ED**  
GX152L  
◆ 2.00m - ◆ 1.48m - ■ 0.85m  
⚡ 12W - ▲ 27.50kg  
FLASH

**TOMMY**  
GX105L  
◆ 2.70m - ◆ 2.50m - ■ 2.20m  
⚡ 50W - ▲ 91.00kg  
FLASH

**ROY**  
GX151L  
◆ 2.00m - ◆ 1.00m - ■ 1.00m  
⚡ 17W - ▲ 27.00kg  
FLASH



Sound and light animated scene composed of several characters and a single buzzer, available on request.

**JOHNNY**  
GX167L  
◆ 2.30m - ◆ 1.60m - ■ 0.90m  
⚡ 27W - ▲ 34.50kg

**JOHNNY**  
GX167L-A  
+ buzzer  
⚡ 35W - ▲ 69.00kg

TO ORDER

**SANTA ROCK**  
GX165L  
◆ 2.80m - ◆ 1.90m - ■ 1.50m  
⚡ 29W - ▲ 69.00kg

**SANTA ROCK**  
GX165L-A  
+ buzzer  
⚡ 37W - ▲ 93.00kg

TO ORDER

**LOU**  
GX166L  
◆ 2.30m - ◆ 2.20m - ■ 2.60m  
⚡ 30W - ▲ 66.50kg

**LOU**  
GX166L-A  
+ buzzer  
⚡ 30W - ▲ 101.50kg

TO ORDER







**HERA**  
GX115LW  
◆ 3.50m - ◆ 2.00m - ■ 2.00m  
⚡ 66W - ▲ 88.00kg - 453  
FLASH

**LITTLE TEDDY CHIC**  
CX087L  
◆ 2.00m - ◆ 2.00m - ■ 1.45m  
⚡ 46W - ▲ 54.00kg  
FLASH

**TRADI BOX**  
CX261LW  
◆ 1.90m - ◆ 1.23m - ■ 0.66m  
⚡ 76W - ▲ 54.00kg - 9  
STARS-FLASH



**MAX**  
GX148L  
◆ 2.20m - ◆ 1.80m - ■ 1.37m  
⚡ 33W - ▲ 128.50kg  
FLASH

**DAVE A**  
SV504A  
◆ 3.12m - ◆ 1.60m - ■ 1.60m  
⚡ 35W - ▲ 44.50kg  
FLASH

**DAVE B**  
SV504B  
◆ 3.12m - ◆ 1.60m - ■ 1.60m  
⚡ 35W - ▲ 44.50kg  
FLASH

**DAVE C**  
SV504C  
◆ 3.12m - ◆ 1.60m - ■ 1.60m  
⚡ 35W - ▲ 44.50kg  
FLASH

**MISTER XMAS**  
GX132L  
◆ 3.60m - ◆ 2.60m - ■ 1.90m  
⚡ 74W - ▲ 97.00kg - 85





**N** THEODOR  
GX263L  
◆ 2.30m - ◆ 0.90m - ■ 0.65m  
⚡ 22W - ⚙ 31.00kg - ⚡ 3  
FLASH

**N** BIGS  
GX264LW  
◆ 1.60m - ◆ 1.90m - ■ 0.80m  
⚡ 122W - ⚙ 76.00kg - ⚡ 948  
FLASH

**N** XMAS TRAIN  
GX102LW  
◆ 1.90m - ◆ 3.55m - ■ 1.00m  
⚡ 124W - ⚙ 130.00kg - ⚡ 33  
FLASH-XLED

TO ORDER

**N** BOX  
GX247L-A  
◆ 2.20m - ◆ 1.70m - ■ 0.90m  
⚡ 236W - ⚙ 107.00kg - ⚡ 986  
STARS-XLED

**N** CIRCUS  
GX267LW  
◆ 3.00m - ◆ 1.80m - ■ 1.80m  
⚡ 248W - ⚙ 116.00kg - ⚡ 132  
FLASH

TO ORDER

**N** FLASH  
GX193L  
◆ 1.25m - ◆ 2.24m - ■ 0.98m  
⚡ 110W - ⚙ 46.00kg  
FLASH-XLED-STARS

**N** LOLITA  
GX244L  
◆ 2.30m - ◆ 2.13m - ■ 1.61m  
⚡ 44W - ⚙ 70.00kg  
FLASH





**TEDDY SKI**  
GX182L  
◆ 4.00m - ◆ 3.36m - ■ 2.60m  
⚡ 146W - ▲ 148.00kg - 📺 41  
XLED

**TEDDY SKI ANIME**  
GX182L-A  
◆ 4.00m - ◆ 3.36m - ■ 2.60m  
⚡ 186W - ▲ 160.00kg - 📺 41  
XLED

With presence detector

TO ORDER



**SUGAR**  
GX248LR

◆ 2.00m - ◆ 0.80m - ■ 0.80m  
⚡ 8W - ▲ 26.00kg  
FLASH

**CANDY SELFIE**  
GX153L

◆ 1.96m - ◆ 1.90m - ■ 1.00m  
⚡ 39W - ▲ 59.00kg  
STARS-FLASH

**KDO**  
SL038W  
SL038R  
SL038B

◆ 1.30m - ◆ 0.90m - ■ 0.90m  
⚡ 20W - ▲ 17.50kg - 📺 250

Lighting system with floodlights





**PETER**  
GX097L    ◆ 2.00m - ◆ 1.30m - ■ 0.60m  
⚡ 20W - ▲ 60.00kg - ⚡ 5

**LETTERBOX**  
GX308L    ◆ 2.00m - ◆ 0.90m - ■ 0.90m  
⚡ 172W - ▲ 43.50kg - STARS-FLASH

**JOHN**  
GX098L    ◆ 2.30m - ◆ 1.50m - ■ 0.90m  
⚡ 30W - ▲ 56.00kg - ⚡ 5

**XMAS BOOTS**  
GX088L    ◆ 2.70m - ◆ 2.45m - ■ 1.40m  
⚡ 157W - ▲ 61.20kg - ⚡ 74  
STARS-FLASH

With push buttons



**TEDDY CHIC**  
GX086L-A    ◆ 4.00m - ◆ 4.02m - ■ 2.82m  
⚡ 248W - ▲ 172.00kg  
FLASH

With presence detector

TO ORDER

**TEDDY CHIC**  
GX086L    ◆ 4.00m - ◆ 4.02m - ■ 2.82m  
⚡ 208W - ▲ 157.00kg  
FLASH

TO ORDER

**MISTER SANTA**  
GX133L    ◆ 2.80m - ◆ 1.76m - ■ 1.40m  
⚡ 46W - ▲ 125.00kg - ⚡ 5  
FLASH





**CLEM**  
GX257LW  
◆ 1.49m - ◆ 1.21m - ■ 0.30m  
⚡ 44W - ▲ 21.00kg - 📏 168  
FLASH



**JOSÉ**  
GX172LW  
◆ 2.15m - ◆ 1.20m - ■ 0.30m  
⚡ 40W - ▲ 15.00kg - 📏 57  
FLASH



**ANGEL**  
GX256LW  
◆ 1.83m - ◆ 1.63m - ■ 0.30m  
⚡ 82W - ▲ 27.00kg - 📏 202  
FLASH



**CLEO**  
GX259LW  
◆ 1.50m - ◆ 1.33m - ■ 0.30m  
⚡ 56W - ▲ 20.00kg - 📏 184  
FLASH

**MANALA**  
GX245LW  
◆ 1.88m - ◆ 1.34m - ■ 0.30m  
⚡ 56W - ▲ 29.00kg - 📏 258  
FLASH

**KRYS**  
GX258LW  
◆ 1.50m - ◆ 1.50m - ■ 0.30m  
⚡ 88W - ▲ 35.00kg - 📏 308  
FLASH

**YUMMY**  
GX262LW  
◆ 1.60m - ◆ 1.30m - ■ 0.30m  
⚡ 36W - ▲ 24.00kg - 📏 346  
FLASH





**XMAS TRAIN**  
GX102L  
◆ 1.90m - ◆ 3.55m - ■ 1.00m  
⚡ 124W - ▲ 130.00kg - ⚡ 33  
FLASH-XLED

**RECY TRAIN**  
GX112L  
◆ 1.95m - ◆ 2.00m - ■ 1.51m  
⚡ 79W - ▲ 80.00kg - ⚡ 68  
FLASH-XLED

**ELY**  
GX260L

◆ 1.60m - ◆ 1.24m - ■ 1.00m  
⚡ 20W - ▲ 12.00kg - ⚡ 67  
STARS

**FUNKY PINGOO**  
GX204L  
◆ 1.60m - ◆ 1.20m - ■ 0.60m  
⚡ 15W - ▲ 19.00kg

TO ORDER

TO ORDER

**RECY TRAIN**  
GX112L-UK  
◆ 1.95m - ◆ 2.00m - ■ 1.51m  
⚡ 79W - ▲ 80.00kg - ⚡ 68  
FLASH-XLED

TO ORDER



**KRYS**  
GX258L  
◆ 1.50m - ◆ 1.50m - ■ 0.30m  
⚡ 88W - ▲ 35.00kg - ⚡ 308  
FLASH

**WIZZ FROZEN**  
GX195L  
◆ 1.20m - ◆ 2.30m - ■ 1.20m  
⚡ 73W - ▲ 82.00kg - ⚡ 153  
XLED-STARS-FLASH

**COMETE**  
GX118L  
◆ 2.60m - ◆ 2.18m - ■ 1.20m  
⚡ 14W - ▲ 27.40kg

**ROMY**  
GX119L  
◆ 4.50m - ◆ 3.00m - ■ 2.45m  
⚡ 29W - ▲ 81.00kg - ⚡ 0



# PLAY MAGIC

## Play in augmented reality!

Allowing audiences to do things like take a photo with Father Christmas or play with Charlie the Unicorn, our augmented reality apps add virtual characters into the real world, leaving the public laughing and amazed.

Children and adults can easily take part in the fun using a smartphone enjoying an unforgettable experience that transforms reality into a unique performance.

### How does it work?

**For the public, the idea is simple:** When users approach the Play Magic banner, the app they have pre-installed on their phones automatically unlocks to give them access to the games.

They can then share the experience on their social media pages. The public app features your branding and a link to your website or social media.

### For the city:

The games app has a subscription model valid while the illuminations are up, with games updated each year.

Apart from this, all you need to do is install the banner near the illuminations to tell the public they can enjoy a free game on their phone in the location. There is no need for any connection.

The app's success also depends on you advertising it on displays in your town/city and on your social media pages.

We can assist you in setting up your communications (Réf. ARCOM below).

Reference	Description
AR001	3 games pack (chosen from the 7 existing games) + 1 Totem
AR002	5 games pack (chosen from the 7 existing games) + 1 Totem
ARTOT02	1 additional Totem
ARCOM	Augmented Reality Communications Pack (non-printed poster, web banner and smartphone-format image).

### Games available:



FR : AR001  
EN : AR001-EN  
ES : AR001-ES



**BILLY**  
GX103L  
◆ 2.70m - ◆ 2.90m - ■ 1.35m  
⚡ 81W - ⚡ 65.50kg - 📶 134  
XLED

**BILLY ANIME**  
GX103L-A  
◆ 2.70m - ◆ 2.90m - ■ 1.35m  
⚡ 121W - ⚡ 78.50kg - 📶 134  
INTERACTIVITE-XLED

With push buttons

TO ORDER

**MARLEY**  
GX146L  
◆ 2.30m - ◆ 2.60m - ■ 0.70m  
⚡ 20W - ⚡ 46.50kg  
FLASH





# CREATE YOUR own Bioprint scenes

Choose from these characters to create your own scene. All the motifs presented are self-supporting on a frame but can also be manufactured in wallmount and polemount (on demand).

- **Choose your frame:** Bauble or Golden Gift (Ref. SC014 or SC015).
- **Choose 2 decorations and create your own scene:** Reindeer, House, Fir Tree, Angel, Sled, Snowflake, Snowman and Gift Packs (Ref. from SC016 to SC025) - Let your imagination run wild!

	<i>Arche xmas</i> SC014	◆ 2.90m - ◆ 2.55m ⚡ 40W - ▲ 26.6kg starflash		<i>Arche frozen</i> SC015	◆ 2.30m - ◆ 2.53m ⚡ 35W - ▲ 21.4kg starflash
	<i>Snowy</i> SC025	◆ 1.55m - ◆ 1.00m ⚡ 20W - ▲ 7.1kg starflash		<i>Rudolf</i> SC016	◆ 1.80m - ◆ 0.80m ⚡ 15W - ▲ 4.6kg starflash
	<i>Tornado</i> SC017	◆ 1.80m - ◆ 1.15m ⚡ 20W - ▲ 6.5kg starflash		<i>Home</i> SC018	◆ 1.70m - ◆ 0.95m ⚡ 20W - ▲ 7.4kg starflash
	<i>Erica</i> SC019	◆ 1.90m - ◆ 1.30m ⚡ 25W - ▲ 8.0kg starflash		<i>Cadeaux</i> SC024	◆ 1.70m - ◆ 0.70m ⚡ 25W - ▲ 9.0kg starflash
	<i>Ronny</i> SC020	◆ 1.64m - ◆ 1.35m ⚡ 15W - ▲ 5.3kg starflash		<i>Rafael</i> SC021	◆ 1.50m - ◆ 1.25m ⚡ 20W - ▲ 6.4kg starflash
	<i>Wizzy</i> SC022	◆ 0.90m - ◆ 1.45m ⚡ 25W - ▲ 6.6kg starflash		<i>Cristal</i> SC023	◆ 1.00m - ◆ 1.75m ⚡ 20W - ▲ 6.8kg starflash





# NORDIKA

## & 3D



# NORDIKA,

*a majestic conifer as realistic as a natural one* **[Blachere  
Exclusivity]**

Who doesn't love a fabulous Christmas tree? And yet, it takes between 30 and 40 years for a natural conifer to reach 12m in height. As we want to avoid deforestation halting the felling of these majestic trees, we invented NORDIKA. Pre-illuminated with a slowglow effect, easy to assemble and store, they are perfect replicas of their natural version, both in their design and incredibly realistic appearance - as true to life as it gets.

Our environmental approach is based on a simple principle: to save at least as much carbon as we generate. We do this by only using biocompatible materials, which we recycle at the end of their lifespan.



**OPTIONAL  
TREETOP**



**HYPER REALISTIC  
CHRISTMAS TREE  
BRANCHES**



**WOOD-EFFECT TRUNK**

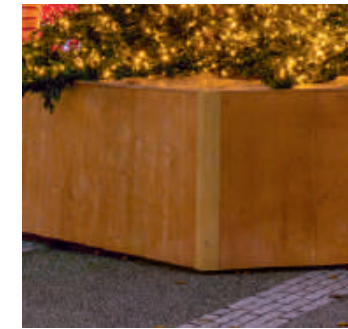

**WOOD EFFECT  
STAND AVAILABLE**

# NORDIKA,

*The Christmas tradition*

The perfect regularity of the branches, the realistic high-quality finishes and a majestic size make our conifers a festive must. You can customise your Nordika every year for a unique look: hang Christmas baubles on its branches, add a set of lights, or even set it on a wooden base.

New construction:  
8 additional branches

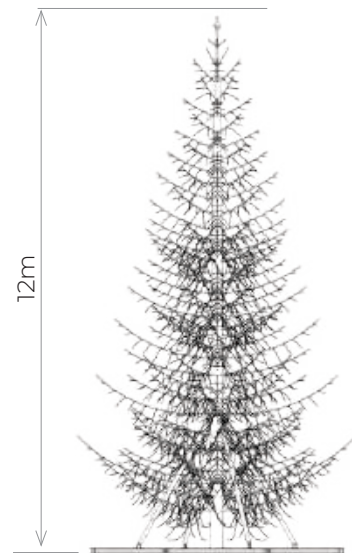
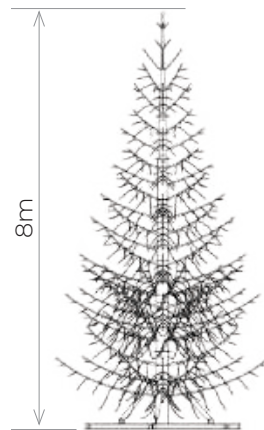
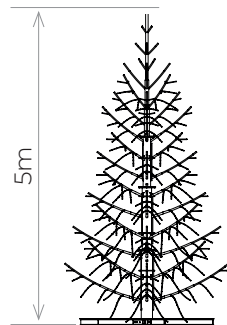

**TO ORDER**

Ref	Name	Height	ø	P(W)	Weight	No of elements	Colour of Led	No of Led
GX081LW-2	sapin Nordika - PM	5,00 m	3,56 m	245 W	263 kg	46		2976 (1488 steady + 1488 with slowglow effect)
GX082LW	sapin Nordika - MM	8,00 m	4,70 m	770 W	1 112 kg	107		8664 (4332 steady + 4332 with slowglow effect)
GX083LW	sapin Nordika - GM	12,00 m	5,90 m	1870 W	2 750 kg	194		21048 (10524 steady + 10524 with slowglow effect)



**FREE STANDING  
NO NEED TO SECURE  
WITH WIRES**

**TOTALLY  
SAFE 24V**

**INDOOR &  
OUTDOOR USE**

**PVC  
FREE**

**PRE-LIGHTED  
WITH 100% LED  
SLOWGLOW EFFECT**

**CAN BE TOTALLY  
DISMANTLED  
(EASY TRANSPORT  
AND STORAGE)**



# NORDIKA,

## Accessories

### Decorative baubles kit

Each kit features 52 baubles in the same colour (M1/B1 category-fireproof)-50% shiny /50% satiny

- 28 baubles ø 12cm
- 20 baubles ø 20cm
- 4 baubles ø 25cm

### Bioprint & Recyprint kit

Each kit features 20 motives

- 8 motives ø 50cm
- 12 motives ø 30cm



Colour	Reference
Silver	<b>KITNDK-A</b>
Blue	<b>KITNDK-B</b>
Gold	<b>KITNDK-O</b>
Red	<b>KITNDK-R</b>

#### Recommendations

- Nordika - 5 m → 2 kits - 104 baubles  
 Nordika - 8 m → 4 kits - 208 baubles  
 Nordika - 12 m → 8 kits - 416 baubles

Colour	Motive	Reference
Blue/White	Snowflake	<b>KITNDK-F</b>
Gold/White	Star	<b>KITNDK-E</b>

#### Recommendations

- Nordika - 5 m → 2 kits - 40 décorations  
 Nordika - 8 m → 4 kits - 80 décorations  
 Nordika - 12 m → 8 kits - 160 décorations

### Base and tree topper

4 tree toppers are available for an additional magical touch to your Nordika tree.

Bases can also be featured with all Nordika trees.



Tree topper	ø	Reference
tree topper star7	0,80m	<b>CIME7</b>
tree topper bella	1,00m	<b>CIME2</b>
tree topper mia	1,00m	<b>CIME6</b>
tree topper aiguille	1,00m	<b>CIME4</b>

Base	Reference
Nordika base 5m (GX081LW-2)	<b>SOCLGX81</b>
Nordika base 8m (GX082LW)	<b>SOCLGX82</b>
Nordika base 12m (GX083LW)	<b>SOCLGX83</b>



**PETIT CELESTE** SV302 \* □  
 ◆ 3.50m - ◆ 1.16m - ■ 1.16m  
 ⚡ 70W - ▲ 34.00kg - 📏 419  
 FLASH-STARS

**CELESTE** SV502 \* □  
 ◆ 6.00m - ◆ 1.90m - ■ 1.90m  
 ⚡ 185W - ▲ 97.00kg - 📏 598  
 FLASH

TO ORDER

**QUADRI TREE** SV303 \* □  
 ◆ 3.00m - ◆ 1.16m - ■ 1.16m  
 ⚡ 55W - ▲ 30.00kg - 📏 199  
 FLASH-STARS



**MARINA** SLED010W \*  
 ◆ 7.50m - ◆ 3.40m - ■ 3.40m  
 ⚡ 265W - ▲ 152.00kg  
 FLASH

TO ORDER

**CELESTE** SV502W \* □  
 ◆ 6.00m - ◆ 1.90m - ■ 1.90m  
 ⚡ 185W - ▲ 97.00kg - 📏 598  
 FLASH

TO ORDER

**QUADRI TREE** SV303W \* □  
 ◆ 3.00m - ◆ 1.16m - ■ 1.16m  
 ⚡ 55W - ▲ 30.00kg - 📏 199  
 FLASH-STARS

**ASTRAL TREE** SL046W \* \* \* □  
 ◆ 2.84m - ◆ 1.82m - ■ 1.82m  
 ⚡ 160W - ▲ 67.30kg - 📏 466  
 XLED

**PETIT CELESTE** SV302W \* □  
 ◆ 3.50m - ◆ 1.16m - ■ 1.16m  
 ⚡ 70W - ▲ 34.00kg - 📏 419  
 FLASH-STARS





**N** *JUDY*  
 SLO49W \* □  
 ◆ 5.00m - ◆ 3.00m - ■ 1.50m  
 ⚡ 150W - ⚖ 74.50kg - 📶 523  
 FLASH-STARS

TO ORDER

**N** *EMY*  
 SLO48 \* □  
 ◆ 5.00m - ◆ 3.00m - ■ 1.50m  
 ⚡ 150W - ⚖ 74.50kg - 📶 523  
 FLASH-STARS

TO ORDER



*ROMANTIC*  
 SND022 \* \*  
 ◆ 8.00m - ◆ 2.70m - ■ 2.70m  
 ⚡ 300W - ⚖ 315.00kg  
 STARS-COMETE-FLASH

TO ORDER

*TEDDY*  
 SND021 \*  
 ◆ 5.50m - ◆ 2.50m - ■ 2.50m  
 ⚡ 325W - ⚖ 172.00kg  
 STARS-FLASH

TO ORDER



Decorative baubles not included



Description	Height	∅	P(W)	Weight	Parts number	○	●	
Conical fir tree 3m	3,00 m	1,18 m	24 W	49 kg	3	SV301	SV301W	
Conical fir tree 5m	5,00 m	1,80 m	60 W	241 kg	6	SV501	SV501W	
Conical fir tree 10m	10,00 m	3,43 m	248 W	985 kg	23	SV1001	SV1001W	TO ORDER
Conical fir tree 14m	14,36 m	5,80 m	640 W	2371 kg	49	SV1401	SV1401W	TO ORDER
Conical "crossing" fir tree 8m	8,00 m	2,78 m	200 W	585 kg	17	SV801-P	SV801W-P	TO ORDER
Conical "crossing" fir tree 12m	12,00 m	4,08 m	440 W	1174 kg	33	SV1201-P	SV1201W-P	TO ORDER



*SAPIN VERT PRE ILLUMINE* ◆ 2,10m - ◆ 1,35m - ■ 1,35m  
GP157W ✨ ⚡ 40W - ▲ 18,00kg

*SAPIN CONIQUE* ◆ 1,40m - ◆ 0,60m - ■ 0,60m  
GSV140B ✨ + FML180 ⚡ 0,20W - ▲ 15,0kg  
GSV140 ✨ + FML180W





**ROMANTICA**  
SL043W ✨  
◆ 2.80m - ◆ 2.20m - ■ 2.20m  
⚡ 140W - ▲ 58.30kg - 📏 226

**VERDE**  
SL045V ✨🟩  
◆ 3.00m - ◆ 2.25m - ■ 2.25m  
⚡ 180W - ▲ 45.50kg - 📏 299

**NORDIKA 3D - ECO**  
SL041W ✨  
◆ 3.00m - ◆ 2.40m - ■ 2.40m  
⚡ 125W - ▲ 72.00kg - 📏 214

Decorative baubles not included



**GRAND VEGA GREEN**  
SND019 ✨  
◆ 6.25m - ◆ 2.20m - ■ 2.20m  
⚡ 275W - ▲ 170.00kg - 📏 286

**GRAND VEGA FROZEN**  
SND017 ✨🟩  
◆ 6.25m - ◆ 2.20m - ■ 2.20m  
⚡ 275W - ▲ 170.00kg - 📏 286

**VEGA GREEN**  
SND018 ✨🟩  
◆ 2.70m - ◆ 0.88m - ■ 0.88m  
⚡ 30W - ▲ 25.50kg - 📏 46

TO ORDER





**N** *BUBBLE*  
GX251LW ✨ ◻ ◻  
◆ 5.00m - ◆ 2.50m - ◻ 2.50m  
⚡ 144W - ⚖ 362.00kg  
FLASH

TO ORDER

**N** *BUBBLE*  
GX251L ✨ ◻ ◻  
◆ 5.00m - ◆ 2.50m - ◻ 2.50m  
⚡ 144W - ⚖ 362.00kg  
FLASH

TO ORDER

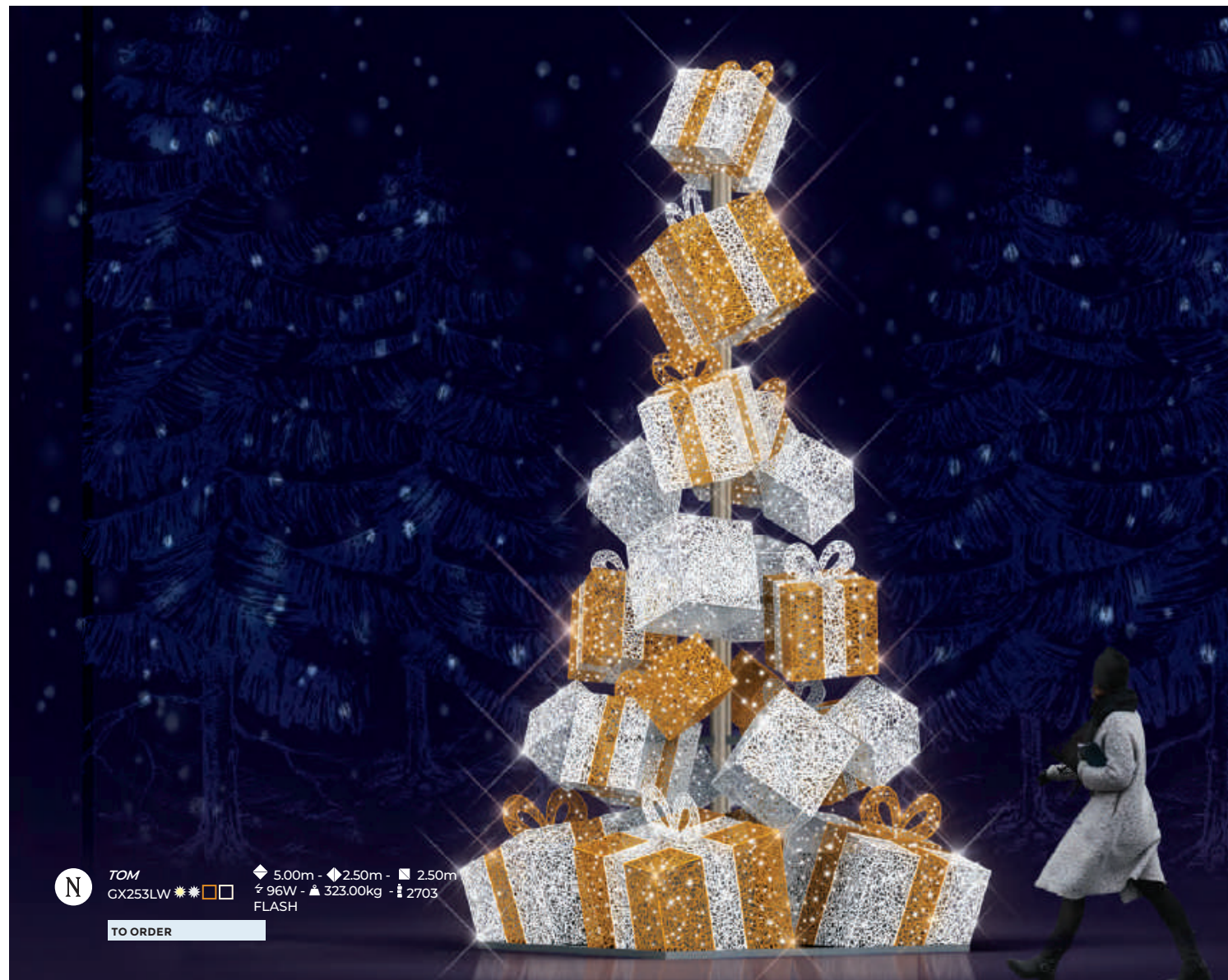

**N** *TOM*  
GX253LW ✨ ✨ ◻ ◻  
◆ 5.00m - ◆ 2.50m - ◻ 2.50m  
⚡ 96W - ⚖ 323.00kg - 📏 2703  
FLASH

TO ORDER







*BJORK PM* ◆ 5.00m - ◆ 1.65m - ■ 0.40m  
 SL039W ✨  
 ✎ 20W - ▲ 40.00kg  
 FLASH

pot included.  
 for facades only.



*BJORK TREE* ◆ 5.00m - ◆ 3.30m - ■ 3.30m  
 SL005W ✨  
 ✎ 100W - ▲ 205.00kg  
 FLASH

*BJORK TREE* ◆ 5.00m - ◆ 3.30m - ■ 3.30m  
 SL005 ✨  
 ✎ 100W - ▲ 205.00kg  
 FLASH





**MAGIC**  
CX173LW ✨ ✨  
◆ 5.13m - ◆ 5.00m - ■ 5.00m  
⚡ 290W - ▲ 175.00kg  
XLED-FLASH

**MAGIC**  
CX173L ✨  
◆ 5.13m - ◆ 5.00m - ■ 5.00m  
⚡ 290W - ▲ 175.00kg  
XLED-FLASH

TO ORDER





**MINI MAGIC**  
GX266DC ✨ ✨  
◆ 2.50m - ◆ 1.60m - ■ 1.60m  
⚡ 178W - ▲ 41.00kg  
FLASH-XLED

**2 in 1 products!**  
You can choose from a warm white or pure white. By reversing the connectors, you can obtain either a pure white decor/ pure white flash or a warm white decor/warm white flash.





**LINE SL**    
 ◆ 3.00m - ◆ 2.00m - ◆ 2.00m  
 ⚡ 210W - ⚠ 44.50kg - 📏 235  
 XLED-FLASH

**LINA**    
 ◆ 3.53m - ◆ 3.86m - ◆ 3.86m  
 ⚡ 140W - ⚠ 60.00kg  
 XLED

**RGBW TREE**

Cycle of different preset animations, changing every two minutes.

**FULL-COLOUR TREE** ◆ 5.70m - ◆ 1.90m - ◆ 1.90m  
 SV506RGBW ⚡ 200W - ⚠ 113.00kg  
 RGBWW

**TO ORDER**



This tree includes Cherrylight® garlands with opaque globes, which diffuse uniform light in zingy colours that change randomly and automatically.

**CHERRY TREE** ◆ 5.80m - ◆ 1.90m - ◆ 1.90m  
 SV505SCL ⚡ 90W - ⚠ 120.00kg  
 RGBWW-FLASH

**TO ORDER**





**FUTURA**  
CX171RGBW

◆ 2.50m - ◆ 6.00m - ■ 4.40m  
⚡ 600W - ⚖ 257.60kg  
RGBWW

TO ORDER

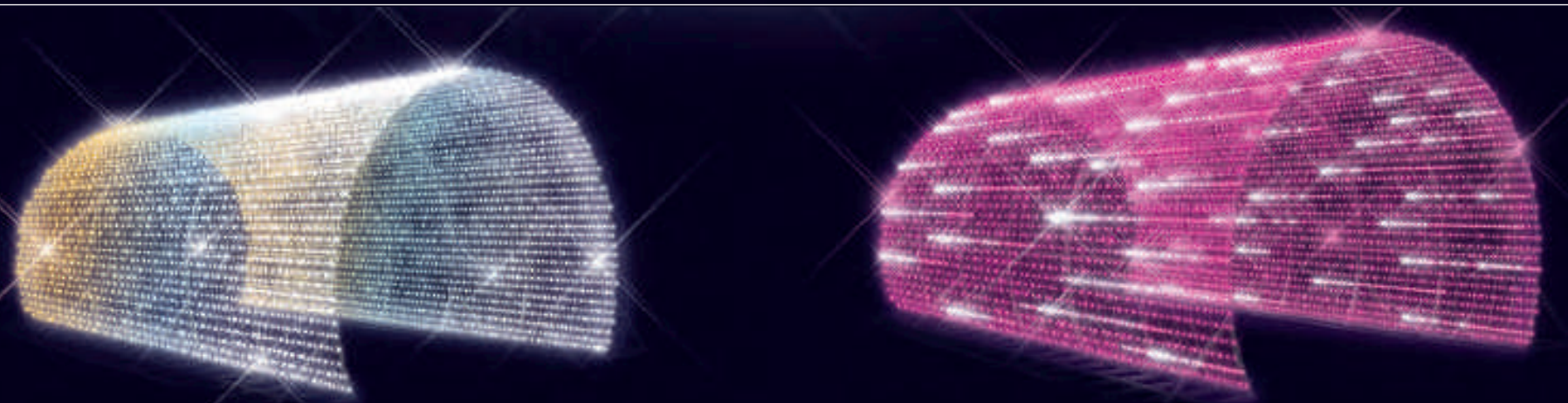

RGBW TUNNEL - Cycle of different preset animations, changing every two minutes.



**CHERRY BOX**  
CX070CL

◆ 3.90m - ◆ 3.60m - ■ 3.30m  
⚡ 175W - ⚖ 235.00kg - ♁ 1927  
FLASH-RGBW

TO ORDER

**CHERRY BALL**  
SL019CL

◆ 2.75m - ◆ 3.00m - ■ 2.24m  
⚡ 58W - ⚖ 162.00kg  
RGBWW

TO ORDER



These decorations includes Cherrylight® garlands with opaque globes, which diffuse uniform light in zingy colours that change randomly and automatically.





**ELIE**  
GX155LW ✨ □  
◆ 4.22m - ◆ 4.00m - ■ 4.00m  
⚡ 382W - ⚠ 386.00kg - 📏 441  
STARS-FLASH

**TATIANA**  
SL035W ✨ ✨  
◆ 2.00m - ◆ 2.10m - ■ 0.60m  
⚡ 60W - ⚠ 22.50kg  
XLED



**TITAN**  
CX070LR ✨ □  
◆ 3.90m - ◆ 3.60m - ■ 3.30m  
⚡ 260W - ⚠ 235.00kg - 📏 1927  
FLASH

**LUMI**  
CX154LW ✨ ✨ ✨ □  
◆ 4.00m - ◆ 2.00m - ■ 1.80m  
⚡ 135W - ⚠ 171.00kg - 📏 1367  
FLASH

TO ORDER





**N** *TRADI ARCH*  
CX252L \* □ □  
◆ 4.58m - ◆ 5.88m - ■ 0.99m  
⚡ 568W - ⚡ 382.00kg  
STARS-FLASH

TO ORDER

**N** *TRADI ARCH*  
CX252LW \* □ □  
◆ 4.58m - ◆ 5.88m - ■ 0.99m  
⚡ 568W - ⚡ 382.00kg  
FLASH-STARS

TO ORDER

TO ORDER



**N** *LOVE ARCH*  
SL050R \* \* □ □  
◆ 5.00m - ◆ 3.00m - ■ 1.50m  
⚡ 75W - ⚡ 70.00kg - ⚡ 832

TO ORDER

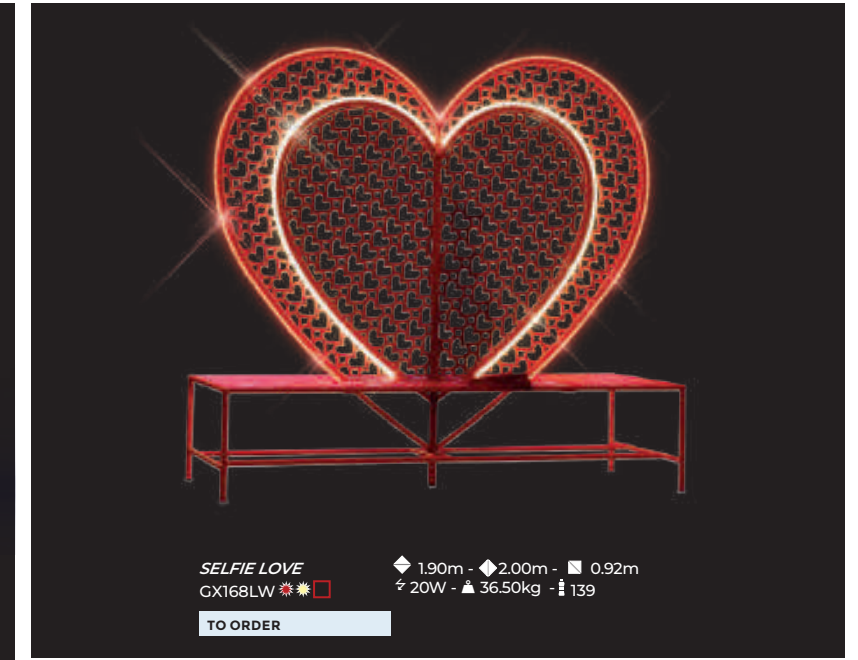

*SELFIE LOVE*  
CX168LW \* \* \* □ □  
◆ 1.90m - ◆ 2.00m - ■ 0.92m  
⚡ 20W - ⚡ 36.50kg - ⚡ 139

TO ORDER



*SELFIE TREE*  
CX156LW \* \* □ □  
◆ 2.47m - ◆ 2.20m - ■ 0.90m  
⚡ 15W - ⚡ 53.50kg - ⚡ 83  
FLASH

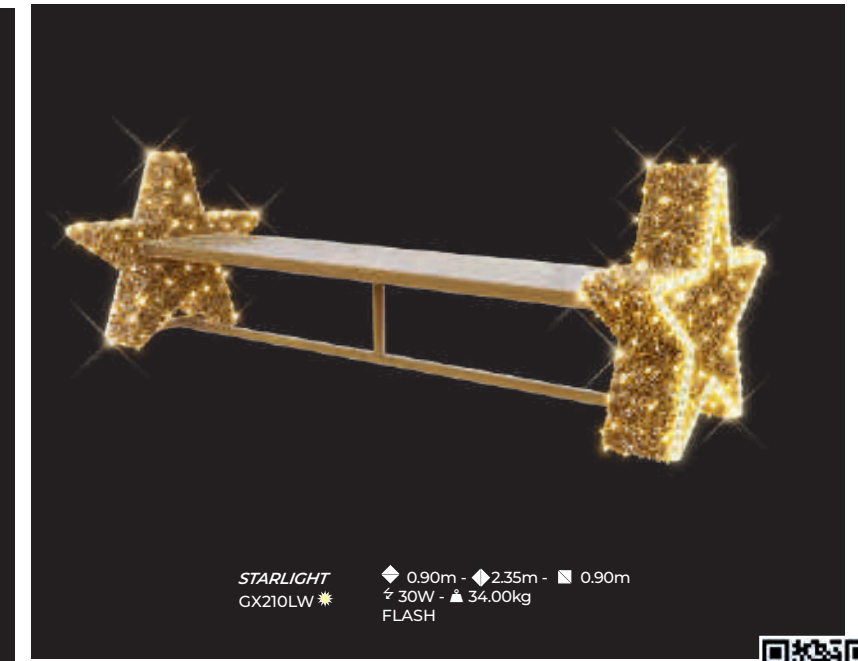

*STARLIGHT*  
CX210LW \* \* \* □ □  
◆ 0.90m - ◆ 2.35m - ■ 0.90m  
⚡ 30W - ⚡ 34.00kg  
FLASH



DEMI ARCHE COMETE  
SL037W

◆ 2.90m - ◆ 1.10m - ■ 1.00m  
⚡ 20W - ▲ 24.00kg - ⚡ 106  
FLASH

DEMI ARCHE FEU D'ARTIFICE  
SL036W

◆ 2.90m - ◆ 1.00m - ■ 0.90m  
⚡ 21W - ▲ 32.00kg - ⚡ 70  
FLASH



PROXIMA PM  
SL012

◆ 1.30m - ◆ 2.50m  
⚡ 25W - ▲ 8.0kg  
FLASH

PROXIMA GM  
SL013

◆ 2.00m - ◆ 3.50m  
⚡ 45W - ▲ 6.0kg  
FLASH

BOULE XMAS  
CX327LW

◆ 1.10m - ◆ 1.00m - ■ 1.00m  
⚡ 25W - ▲ 6.6kg  
FLASH

PROXIMA PM  
SL012W

◆ 1.30m - ◆ 2.50m  
⚡ 25W - ▲ 8.0kg  
FLASH

PROXIMA GM  
SL013W

◆ 2.00m - ◆ 3.50m  
⚡ 45W - ▲ 6.0kg  
FLASH



DEMI ARCHE FEU D'ARTIFICE  
SL036

◆ 2.90m - ◆ 1.00m - ■ 0.90m  
⚡ 21W - ▲ 32.00kg - ⚡ 70  
FLASH

BOULE XMAS  
CX327L

◆ 1.10m - ◆ 1.00m - ■ 1.00m  
⚡ 25W - ▲ 6.6kg  
FLASH

SYLVESTRE GM  
SL033

◆ 2.10m - ◆ 2.50m - ■ 2.50m  
⚡ 45W - ▲ 8.8kg  
FLASH

SYLVESTRE GM  
SL033W

◆ 2.10m - ◆ 2.50m - ■ 2.50m  
⚡ 45W - ▲ 8.8kg  
FLASH

SYLVESTRE PM  
SL032

◆ 1.40m - ◆ 1.65m - ■ 1.65m  
⚡ 40W - ▲ 7.6kg  
FLASH

SYLVESTRE PM  
SL032W

◆ 1.40m - ◆ 1.65m - ■ 1.65m  
⚡ 40W - ▲ 7.6kg  
FLASH





**BLIZZARD ARCH** ◆ 3.47m - ◆ 4.95m - ▣ 0.95m  
 ⚡ 100W - ⚖ 115.00kg - ⚡ 337  
 FLASH - FL900E-COMETEe

TO ORDER

**GOLD ARCH** ◆ 3.47m - ◆ 4.95m - ▣ 0.95m  
 ⚡ 100W - ⚖ 115.00kg - ⚡ 337  
 FLASH - FL900E-COMETEe

TO ORDER

Ballasting option, possible upon request.



**ASTRAL ARCH** ◆ 3.75m - ◆ 4.93m - ▣ 1.00m  
 ⚡ 80W - ⚖ 88.00kg - ⚡ 205  
 FLASH - XLED

TO ORDER

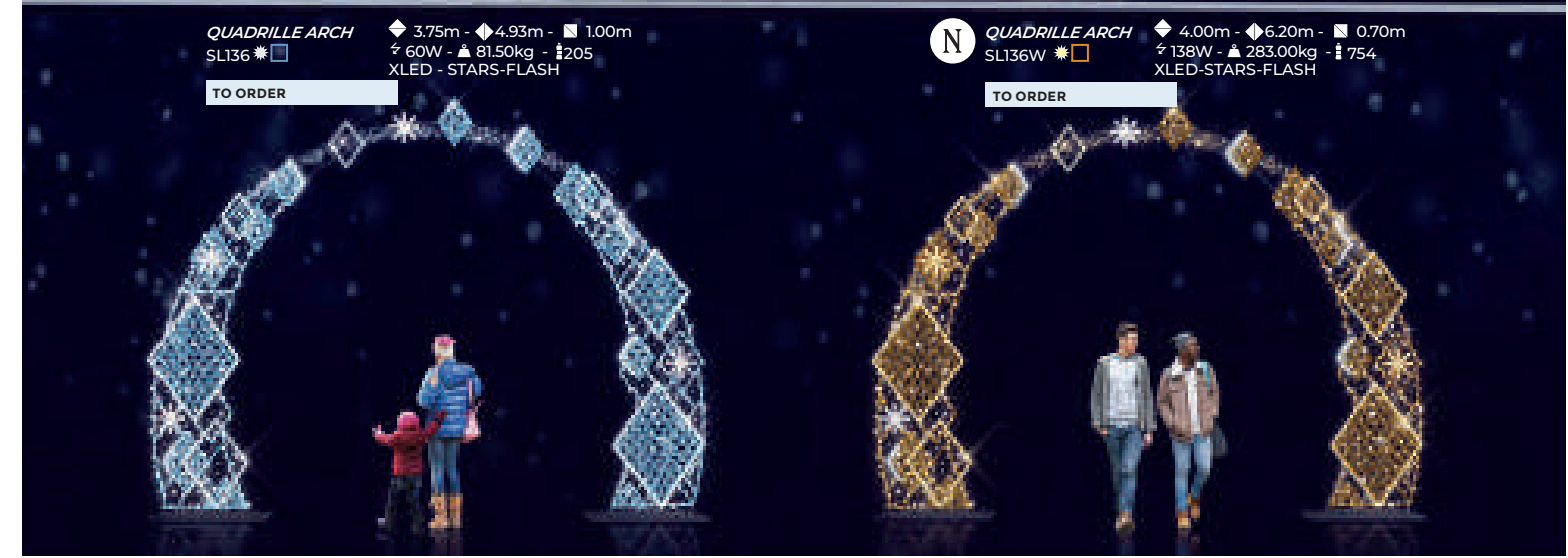

**QUADRILLE ARCH** ◆ 3.75m - ◆ 4.93m - ▣ 1.00m  
 ⚡ 60W - ⚖ 81.50kg - ⚡ 205  
 XLED - STARS-FLASH

TO ORDER

**QUADRILLE ARCH** ◆ 4.00m - ◆ 6.20m - ▣ 0.70m  
 ⚡ 138W - ⚖ 283.00kg - ⚡ 754  
 XLED-STARS-FLASH

TO ORDER







*ASTRAL FONTAIN* ◆ 2.00m - ◆ 4.00m - ■ 4.h  
 SLO44W ✨ ✨ ✨ □  
 ⚡ 120W - ⚙ 82.00kg - 📶 122  
 XLED

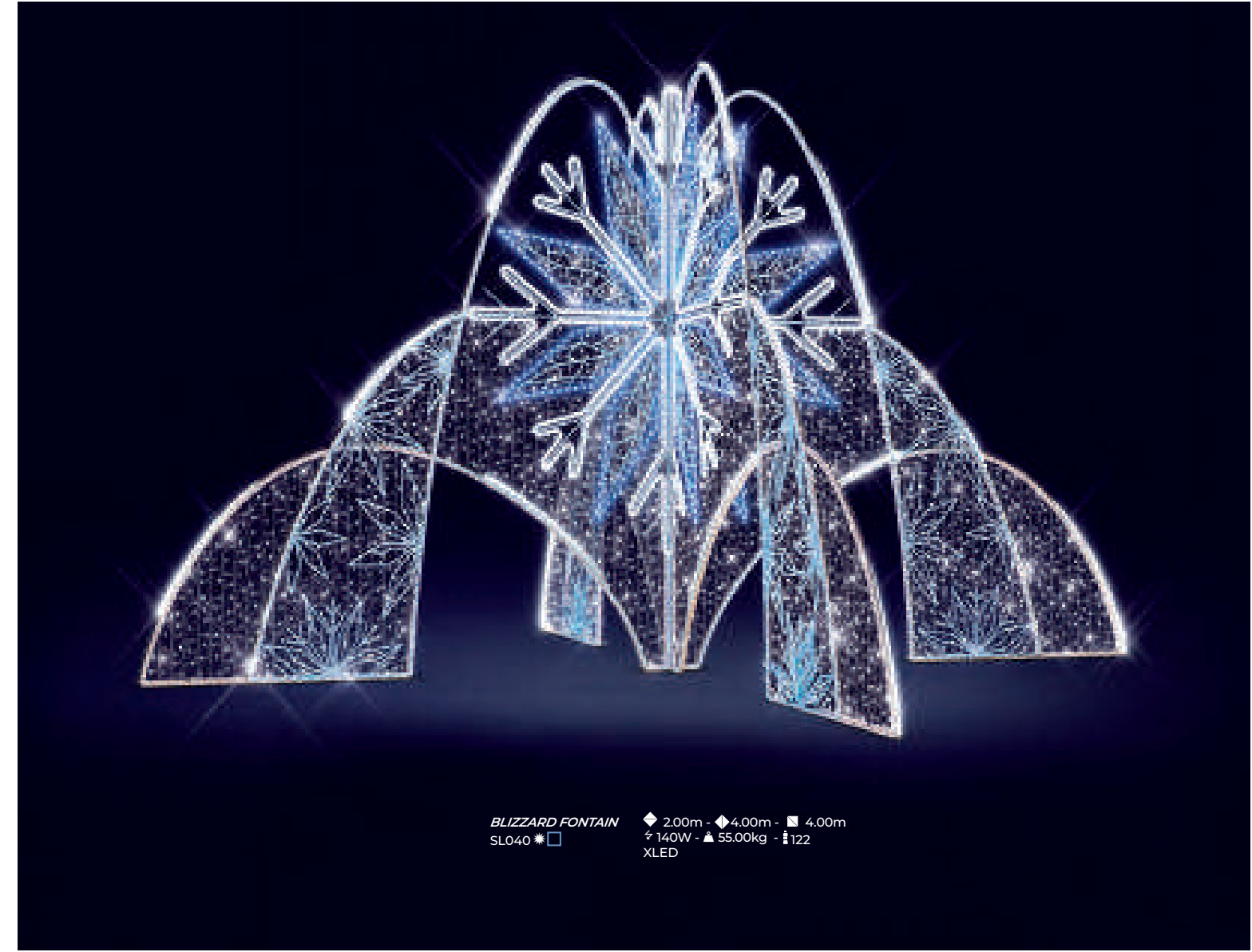

*BLIZZARD FONTAIN* ◆ 2.00m - ◆ 4.00m - ■ 4.00m  
 SLO40 ✨ □  
 ⚡ 140W - ⚙ 55.00kg - 📶 122  
 XLED





# 3D DECOR

## *Funny animal containers*



By encouraging today's youth to recycle is a major challenge that we have answered with creativity and fun. We have made this vital step a fun and playful collective act thanks to creating containers in the form of funny animals.

Placed in city centres or by beaches, whales, trains and other cute creations house recycling containers. The plastic bottles collected are recovered by specialist organisations who process the bottles to provide the raw materials we injected into our printers for the production of structures in Recyprint, our material made from PET (polyethylene terephthalate) from the food industry.

Thanks to Recyprint, we make beautiful and responsible Christmas decorations!

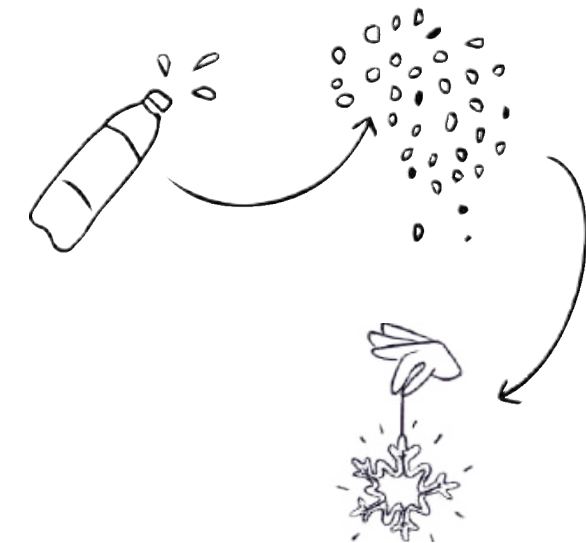

# 3D DECOR

## Funny animal containers

1. **SIMON**  
GX110 ■ ■  
TO ORDER

◆ 2.00m - ◆ 1.50m - ■ 3.30m  
▲ 54.50kg - ⚡

**SIMON**  
GX110-UK ■ ■  
TO ORDER

◆ 2.00m - ◆ 1.50m - ■ 3.30m  
▲ 54.50kg - ⚡

2. **BERGAMOTE**  
GX109 ■ ■  
TO ORDER

◆ 2.30m - ◆ 3.88m - ■ 1.70m  
⚡ - ▲ 71.50kg - ⚡159

**BERGAMOTE-UK**  
GX109-UK ■ ■  
TO ORDER

◆ 2.30m - ◆ 3.88m - ■ 1.70m  
⚡ - ▲ 71.50kg - ⚡113

3. **GAIA**  
GX108 ■  
TO ORDER

◆ 2.30m - ◆ 4.00m - ■ 2.10m  
⚡ - ▲ 82.00kg - ⚡643

**GAIA-UK**  
GX108-UK ■  
TO ORDER

◆ 2.30m - ◆ 4.00m - ■ 2.10m  
⚡ - ▲ 82.00kg - ⚡643

4. **BULLE**  
GX107 ■  
TO ORDER

◆ 2.30m - ◆ 3.70m - ■ 2.10m  
⚡ - ▲ 86.00kg - ⚡745

**BULLE-UK**  
GX107-UK ■  
TO ORDER

◆ 2.30m - ◆ 3.70m - ■ 2.10m  
⚡ - ▲ 86.00kg - ⚡745



1.

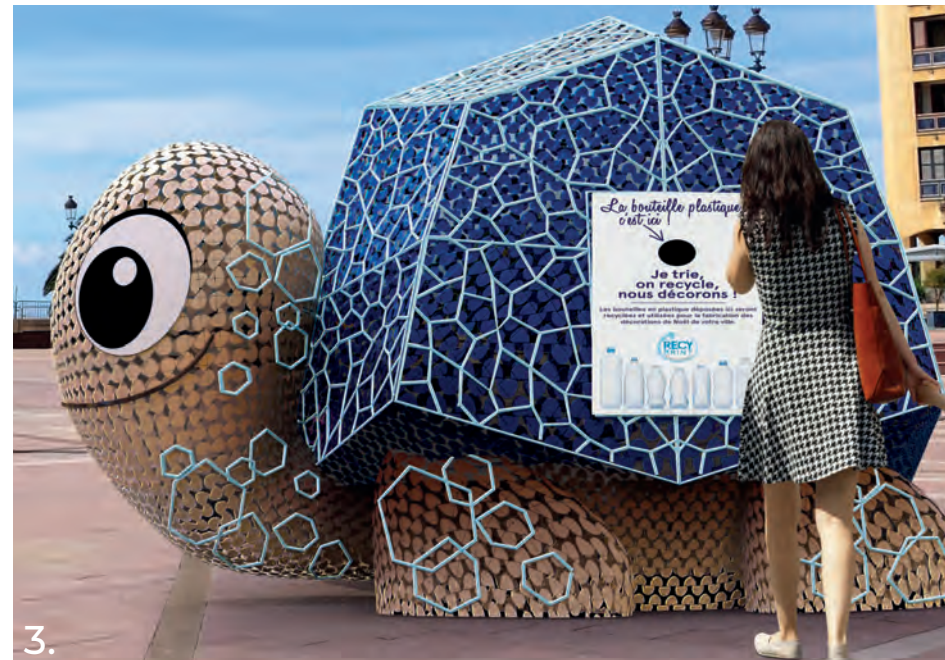

3.

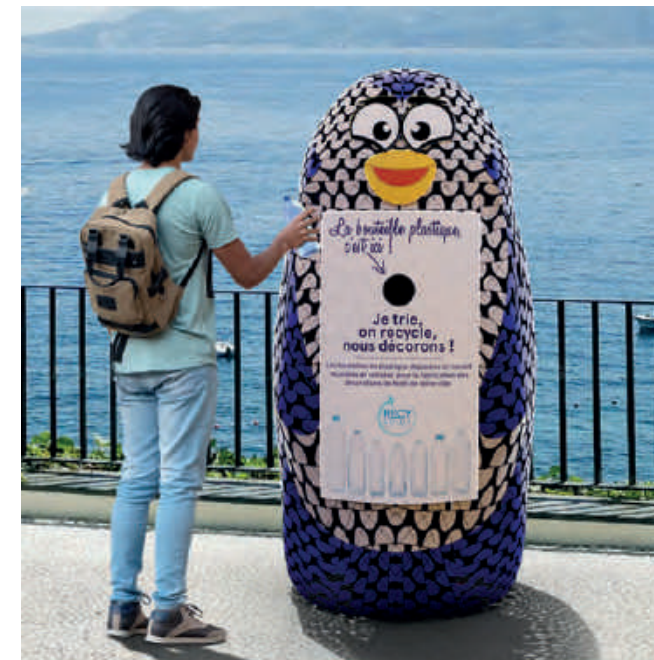

2.



4.

*Decoration suggestion to adorn a small-size container, available on demand, ask your business manager.*

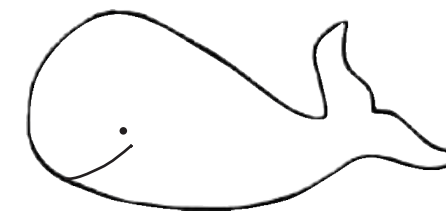



# 3D DECOR

## *Bi-season arch & tree*

Discover our bi-seasonal urban furniture which changes over the seasons according to the chosen decoration kit.

First of all select your base:

- A bright arch composed of pure white LEDs, livened up with wooden benches
- A shade tree endowed with pure white LED spots and a white wooden bench base equipped with USB plugs.

Then, for a colourful summer look, add the SUMMER passive decoration kit to this base.

For a frosted look for year-end celebrations, add the WINTER bright decoration kit.



# 3D DECOR

## Bi-season arch & tree

To order the decorations displayed on this double page, select the references described hereafter:



1. **BASE ARCH**  
SLI34  
◆ 3.5m - ◆ 5.0m - ■ 3.6m  
⚡ 40W - ▲ 245.3kg  
With light

**KIT ARCH SUMMER**  
KIT2-134  
39 passive decorations  
▲ 21.7kg

2. **BASE ARCH**  
SLI34  
◆ 3.5m - ◆ 5.0m ■ 3.6m  
⚡ 40W - ▲ 245.3kg  
With light

**KIT ARCH CHRISTMAS**  
KIT1-134  
39 light & passive decorations  
⚡ 403W - ▲ 41.0kg

3. **BASE**  
GX242L  
◆ 3.0m - ◆ 3.2m - ■ 3.2m  
⚡ 40W - ▲ 127.0kg  
With light

**KIT SUMMER**  
KIT2-242  
36 passive decorations  
▲ 38.0kg

4. **BASE**  
GX242L  
◆ 3.0m - ◆ 3.2m - ■ 3.2m  
⚡ 40W - ▲ 127.0kg  
With light

**KIT CHRISTMAS**  
KIT1-242  
27 light & passive decorations  
⚡ 240W - ▲ 56.7kg

5. **PALM**  
GX243LW  
◆ 3.6m - ◆ 3.2m - ■ 3.2m  
⚡ 24W - ▲ 160.0kg  
With light





# 3D DECOR

*Tree corset*

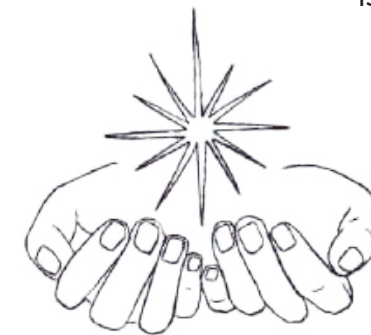

**Embellish your tree trunks!**

Our tree corsets will adorn and light up your trees while protecting them and ensuring optimal hold.

Available in a wide array of colours, there are unlimited combinations to liven up your urban areas or green spaces with style and creativity.

Customised project, contact us.





# 3D & 2D DECOR

## Letter & spotlights

Decorate roundabouts of your town or village with our 2D lettering printed in Bioprint and mounted on a frame.

Each letter is equipped with two warm white spotlights that will enhance your decorations even at night.

Letters available in 1,40m and 2m height.



Custom project, letter 3D possible.

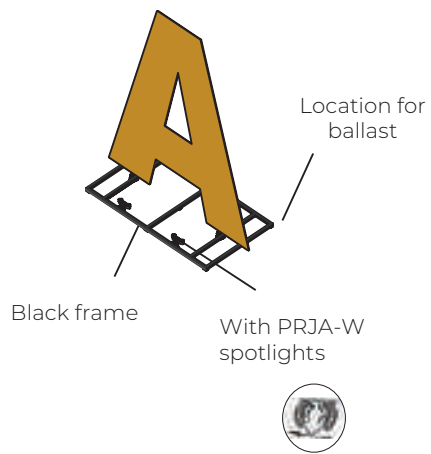



## 2D DECOR

### *Dressing city barriers & planters*

Adorn your urban furniture with colourful environmentally-friendly decorations!

Polar theme, tradi or star — customise the decoration of your town barriers or planters.

You can choose the background colour of the decoration as well as the motif which will be applied on top, everything will be tailor-made in Bioprint, our biodegradable, recyclable material.

Customised project, contact us.

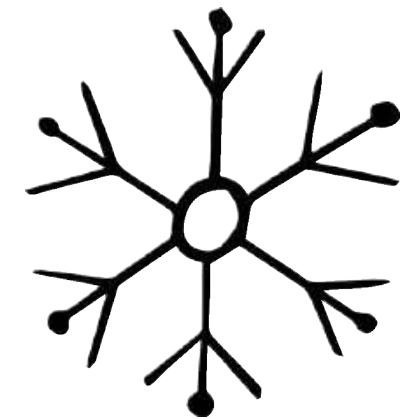



# Garlands summary

## 1 Garlands

158 — 171

## 2 Curtains

172 — 185

## 3 Stalactites

186 — 191

## 4 Ceilings

192 — 193

## 5 Braids

194 — 200

## 6 Decorations

201 — 239

- ◆ Height
- ◀▶ Length
- ▣ Width
- P(W) Wattage
- ||| Number of strings
- 🔌 Number of garlands that can be connected end-to-end
- ⚡ Voltage
- ☒ Weight
- ◻ White cable
- ◼ Black cable
- ◼ Green cable
- ◼ Silver cable
- ◼ Brown cable
- ◻ Transparent cable
- ☀ Pure white Led flash
- ☀ Warm white Led flash
- ☀ Flash Duocolor
- Pure white Led
- Warm white Led
- Blue Led
- Red Led
- Amber Led
- Pink Led
- Green Led
- Multicoloured Led
- Led Duocolor
- 🏠 Indoor/outdoor use
- 📄 rubber Type of cable
- ⚡ 230V Supply voltage
- 💧 IP66-69 Protection rating
- 🔌 incl. Power supply included
- 🔨 IK06 Shock resistance index
- ☠ 230V Octoplus by blachere® 230V exclusive range
- ☠ 24V Octoplus by blachere® 24V exclusive range

# Blachere LEDs

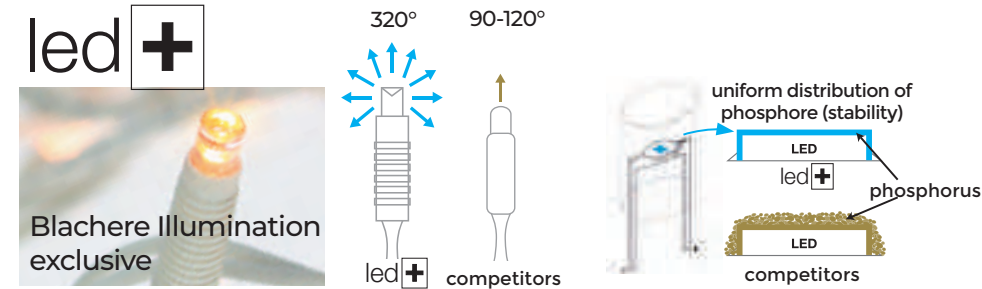

By considering practical use in their innovative designs, our R&D department has devised the all-new LED+ in both static and slowflash editions to make your projects come alive! Our new and exclusive LED range is the outcome of a long-term collaboration with Nichia®, the world leader in LEDs. The range is:

**+ bright, + robust, + long span, + consistent in terms of color**

The new technical features of LED+:

- ▶ **Design is optimized and registered** to promote the luminous efficiency of our product (inverted cone principle).
- ▶ **Thermal dissipation is maximized** for longer LED life
- ▶ **Uniform phosphorus deposition** for a uniform lighting effect.
- ▶ **2 years guarantee**
- ▶ **Optimum protection index: IP66 / IP69**
- ▶ **Octoplus 230V Connection System by Blachere IP67**

**LED+ range: higher performance, lower energy consumption**

Blachere is committed to meeting environmental and energy challenges: **In 2024, we will be lowering the power consumption of our LED+ range in order to reconcile illuminations with energy efficiency.**

Following extensive work on the energy performance of our LEDs, **we have reduced the power of our LED+ range by 15% on average, while retaining its brightness and lifespan.** (the wattage of each product has been updated in our technical information tables).

As a result, **our products consume less energy and yet maintain the same high light density.**

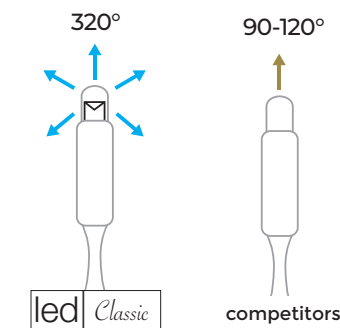

### Our standard LED model!

Bright and stable (lifespan and colour), our Classic LEDs has also inverted cones (homogeneous light diffusion).

Its production is closely followed to make sure the quality is optimal and competitive on the market.  
 230V model: IP66  
 24V model: IP55



# Sparklight® garlands & Duo Colors® Garland *with flash*

N

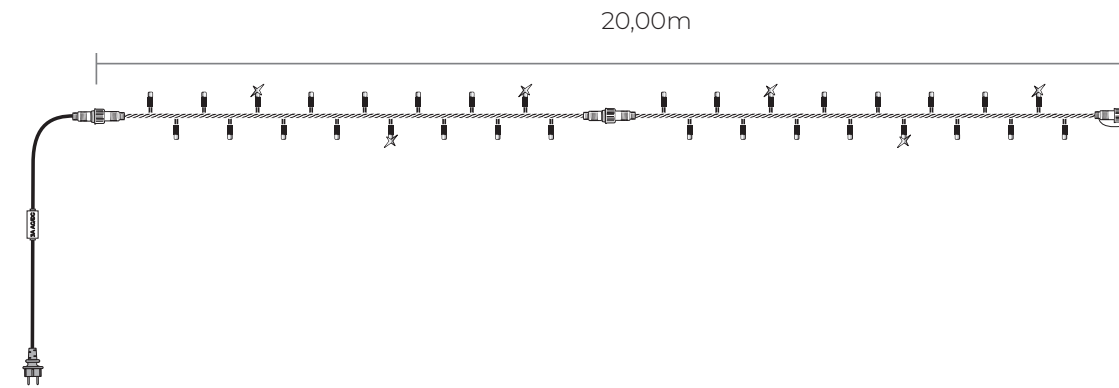

product info

**2 products in 1!**  
Your garland can be either warm white or pure white. Reverse the connection to obtain pure white/pure white flash or warm white/warm white flash. See DUO COLORS® Decor Collection p 32-33).

◆	LED	FLASH	P (W)	🔌	■
20.00m	120 🟡	40 ☀️	14	5	530WWF



# Sparklight® garlands

## Led+ & slowflashes



requires 230V power supply cable L: 1,50m FY08+ type... and bridge rectifier FY043+ type.

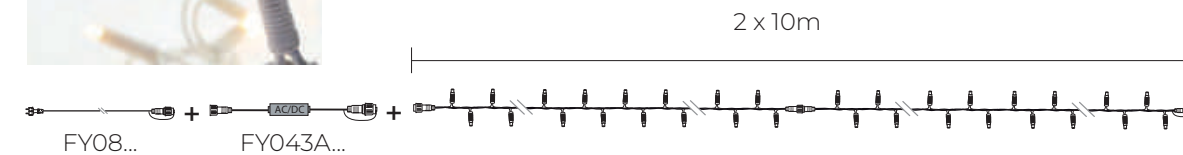

### ▶ with flash

◀	LED	SLOWFLASH	P (W)	🏠	□	■
20.00m	108 ○	52 ⦿	10	5	FL590BF+	FL590F+
20.00m	108 ●	52 ●	10	5	FL590WBF+	FL590WF+
20.00m	108 ●	52 ⦿	10	5		FL590BLF+
20.00m	108 ●	52 ⦿	10	5		FL590RF+

### ▶ static

◀	LED	P (W)	🏠	□	■
20.00m	160 ○	10	5	FL590-B+	FL590+
20.00m	160 ●	10	5	FL590W-B+	FL590W+
20.00m	160 ●	10	5		FL590BL+
20.00m	160 ●	10	5		FL590R+

### accessories needed to operate these products

			□	■
1,50 m	230V power supply cable		FY08-B+	FY08+
0,30 m	bridge rectifier	690W max	FY043A-B+	FY043A+
0,20 m	bridge rectifier	230W max	FY041A-B+	FY041A+

**INNOVATION 2024**  
Our optimised LED+ :  
**-15% reduction**  
in consumption electrical  
(on average)

**+brightness**

### product info

Blachere exclusive  
- Registered design  
- High brightness  
- Shock resistant IK06  
- Long lifespan  
- Stable colour  
- IP 66/69 protection rating.  
Maximum rating allowed for a  
230V product  
- Flexible connectivity thanks to  
the extensive Octoplus 230V by  
Blachere range.

**2 YEARS GUARANTEE**

conditions : contact us

## Sparklight® garlands with flash or static



20 m

2 x 10 m

510-FX

▶ 100% flash

510BW-FX, 510W-FX, 510B-FX, 510R-FX, 510P-FX, 511-FX, 511B-FX, 512-FX, 512W-FX, 508-B, 508, 508W-B, 508W, 508B, 512C, 512CW

◀	FLASH	P (W)	☐	■
20.00m	80 ○	6	5	510-FX

▶ with flash

◀	LED	FLASH	P (W)	☐	■	
20.00m	90 ○	30 ○	8	5	512-FX	
20.00m	90 ●	30 ○	8	5	512W-FX	
20.00m	150 ○	50 ○	12	5	511B-FX	511-FX
20.00m	150 ●	50 ○	12	5	510BW-FX	510W-FX
20.00m	150 ●	50 ○	12	5		510B-FX
20.00m	150 ●	50 ○	12	5		510R-FX
20.00m	150 ●	50 ○	15.5	5		510P-FX

▶ static

◀	LED	P (W)	☐	■	
20.00m	200 ○	15	5	508-B	508
20.00m	200 ●	15	5	508W-B	508W
20.00m	200 ●	15	5		508B
20.00m	120 ○	8	5		512C
20.00m	120 ●	8	5		512CW

### product info

Proven reliability.  
Power supply with connecting socket included.  
Wide range of Octopus 230V by Blachere accessories available.

High flash concentration on FX models.  
Increased waterproofing thanks to optimum protection rating.





## Sparklight® 24V garlands with flash or static



### with PVC cable

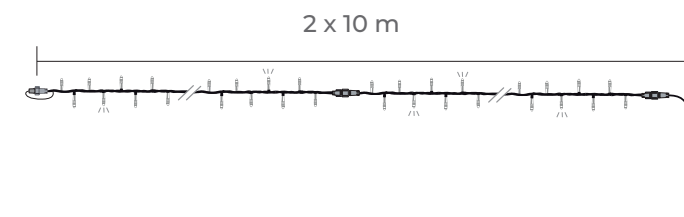

#### ▶ with flash

◀	LED	FLASH	P (W)	🔌	■
20.00m	168 ○	28 ☉	5	5	FL502-FX
20.00m	168 ●	28 ☉	5	5	FL502W-FX
20.00m	168 ●	28 ☉	5	5	FL502B-FX
20.00m	168 ●	28 ☉	5	5	FL502R-FX

#### ▶ static

◀	LED	P (W)	🔌	■
20.00m	196 ●	5	5	501W

### with rubber cable

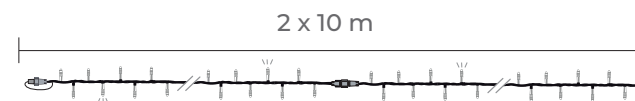

#### ▶ static

◀	LED	P (W)	🔌	■
20.00m	196 ●	6.2	4	501CW
switch-mode power supply 24V dc 25W - sold separately				PRTR24V

### product info

Very low voltage ideal for safe installations within the reach of the public.

High protection rating to withstand dirt and moisture. Long lengths are possible by connecting several garlands using one transformer.

Ref 501CW: more durable rubber cable, ideal for permanent use.

Wide range of Octoplius 24V by Blachere accessories.

## Micro light + PRO® Range *garlands*

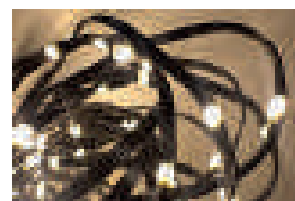

19,20 m

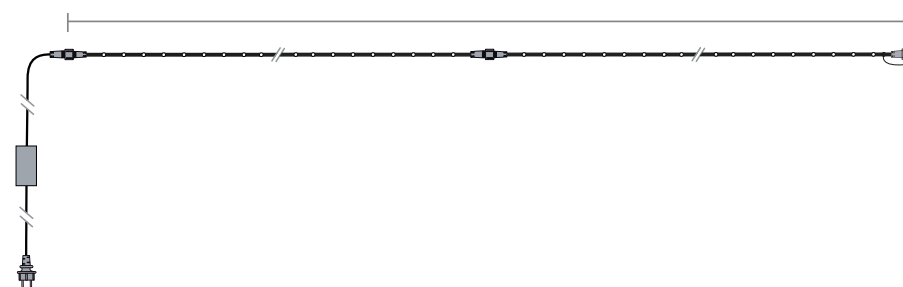

### ▶ Micro light + PRO garlands

◀	LED	P (W)	☑	■
19.20m	192 ○	15	2	501+
19.20m	192 ●	15	2	501W+

### product info

This new Micro light + PRO range has been designed to be more powerful and brighter, while remaining low consumption and with a homogeneous wide angle light diffusion.

Power supply with connection plug included.



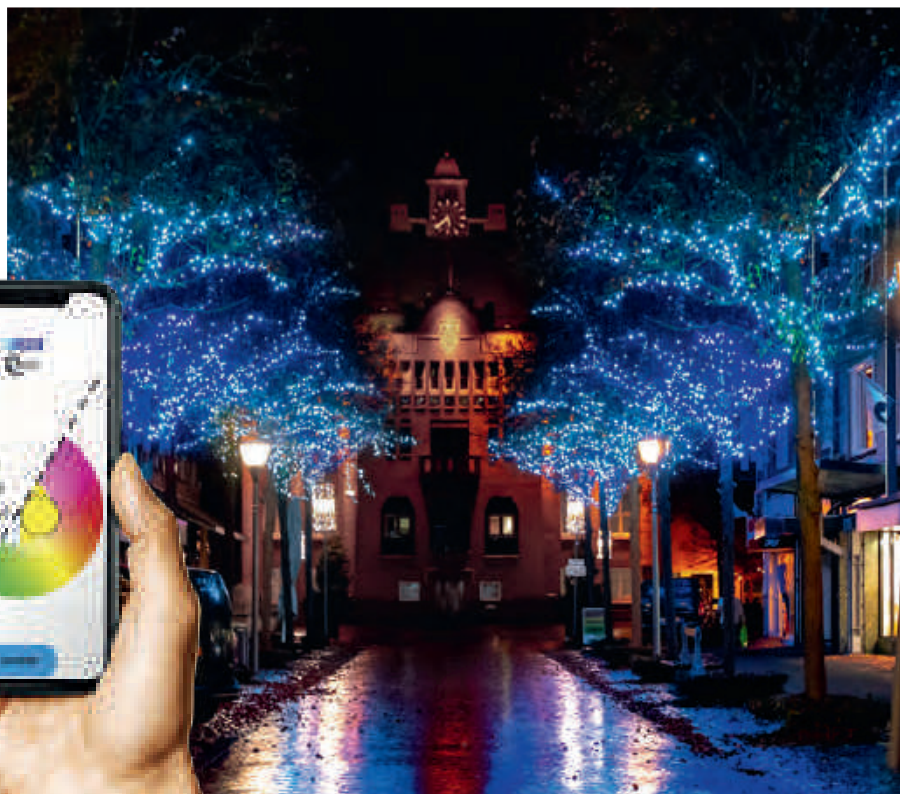
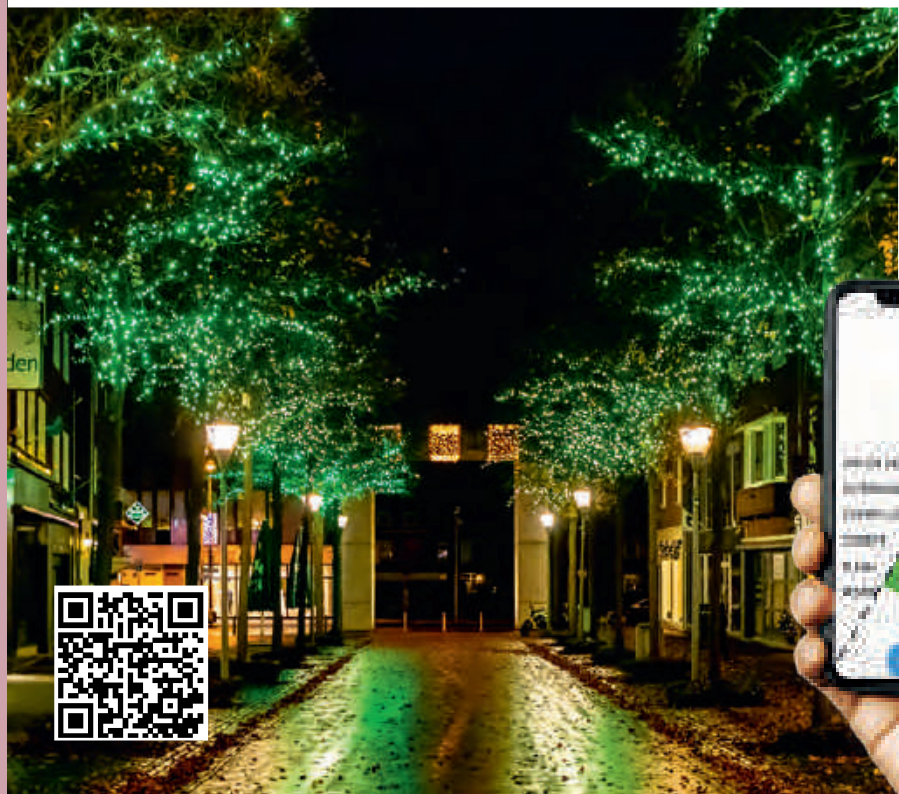

# Controllable RGB garland *with changing colours*

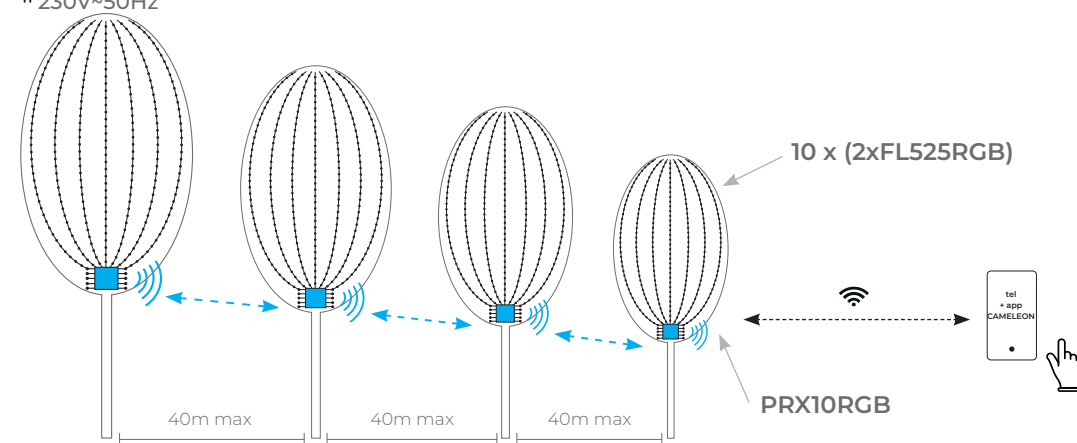
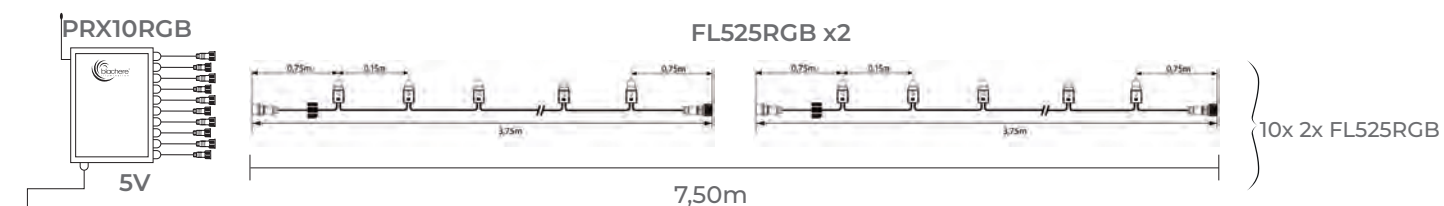

description	◄	LED	P (W)	📶	■	
RGB - 5V	3,75 m	25 RGB	7,5	2	<b>FL525RGB</b>	
Caméléon Control box	input voltage	output voltage	No of pixels	P (W)	No of outputs	Ref
	230V	5V	10 x 50 = 500	150	10	<b>PRX10RGB</b>

**product info**

Customise the lighting, colour and look of your trees, monthly, weekly or for special events throughout the year.

For a tree of 8 m 10m:

- 20 FL525RGB strands for 10 radii of 7.50 m (2x3.75),
- a PRX10RGB box
- the Cameleon application on your smartphone.

Maximum colour spectrum thanks to RGB LED technology. Bluetooth 5 communication between sets, wifi communication between phone + sets.



# Controllable RGBWW garland with changing colours

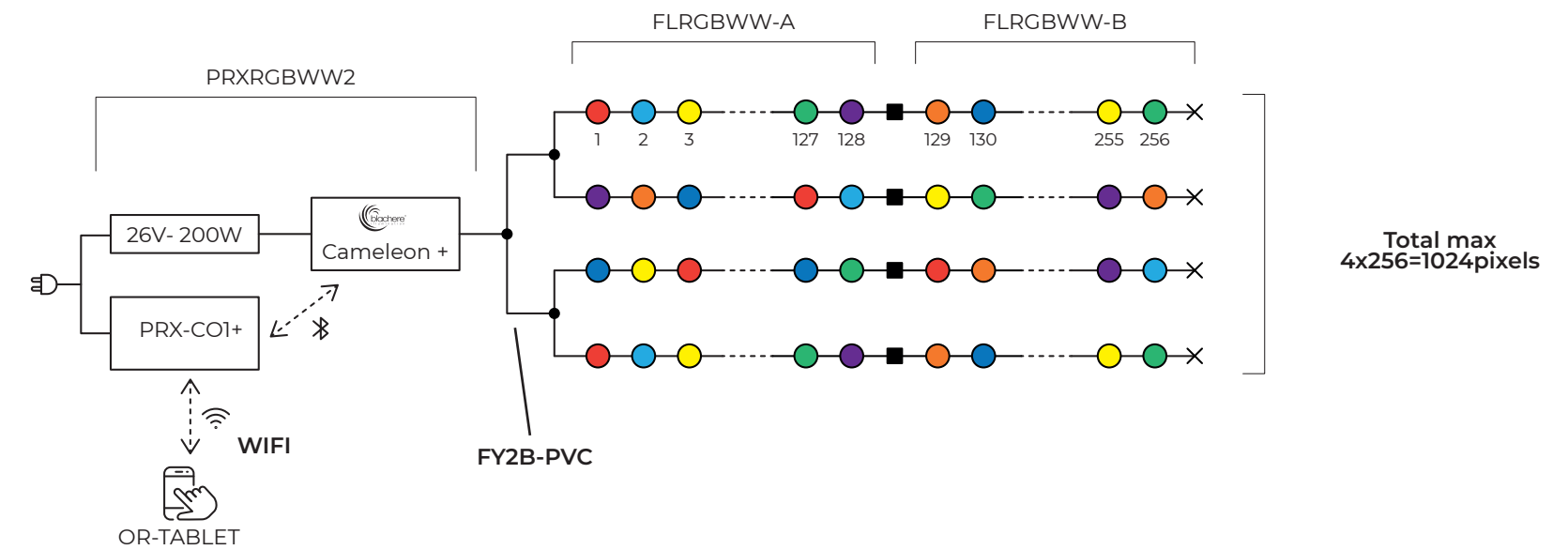

□			Nb leds	◀	P(W)
FLRGBWW-A	1-128	12,80 m	1-128	12,80m	20
FLRGBWW-B	129-256	12,80 m	129-256	12,80m	20
PRXRGBWW2	Cameleon+ Kit (power supply + 26V/200W transformer + animator - 2 outputs)				
FY2B-PVC	Y connection for 4 outputs				
PRX-CO1+	Gateway box				
OR-TABLET	Programming tablet				

**product info**

RRGBWW garland for a mix of colours with a single selectable warm white tint.

Customisable predefined animations.

Wireless configuration using the Cameleon+ effects programmer. LED spacing: 10cm.





1. Warm white

2. Flash

3. Warm white + flash

# «Sobrillance» Concept *Champs-Élysées*

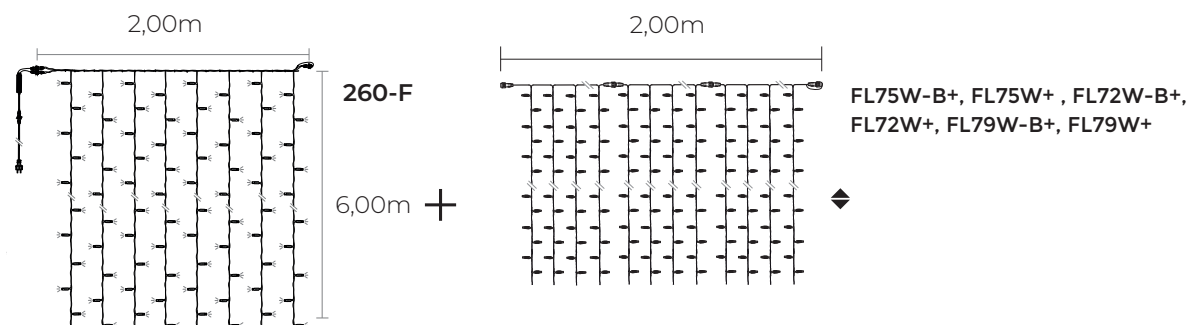

▶ Flash Joylight Led Super Bright® flash

◆	◀	FLASH	P (W)	⏏	🔌	■
6,00m	2,00m	80 ◉	20	8	5	260-F

▶ Static curtains Led+

◆	◀	LED	P (W)	⏏	🔌	□	■
5,00m	2,00m	540 ●	60	15	9	FL75W-B+	FL75W+
7,00m	2,00m	750 ●	60	15	9	FL72W-B+	FL72W+
10,00m	2,00m	1050 ●	69	15	9	FL79W-B+	FL79W+

accessories needed to operate these products

1,50m	power supply cable		□	■
0,30m	bridge rectifier	690W max	FY043A-B+	FY043A+
0,20m	bridge rectifier	230W max	FY041A-B+	FY041A+

**INNOVATION 2024**  
Our optimised LED+ :  
**-15% reduction**  
in consumption electrical  
(on average)  
**+brightness**

product info

Sobrillance is the combination of a static warm white curtain and a Super Bright flash curtain.

Vary the sequences with our remote controlled/programmable clock and create a living light show in your street!  
**On special request.**



## Curtain Joylight Led Super Bright® flash

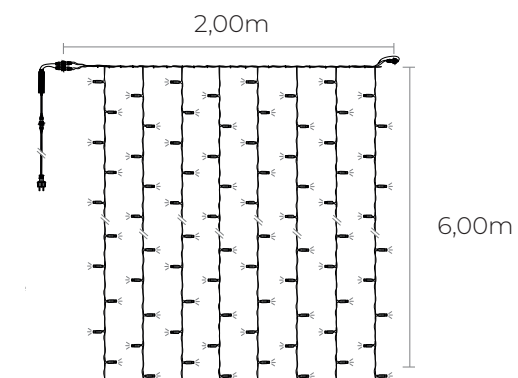

◆	◆	FLASH	P (W)	⏏	🔌	■
6,00 m	2,00m	80 ⦿	20	8	5	260-F

## Garland Sparklight Led Super Bright® flash

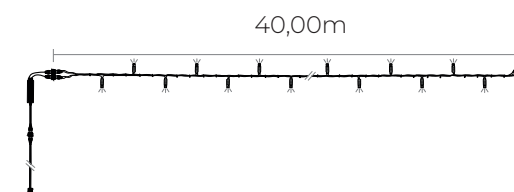

◆	FLASH	P (W)	⏏	■
40,00m	80 ⦿	20	2	560-F

Livree en rouleau de 40m.

### info produit

Sobrillance is the combination of a static warm white curtain and a Super Bright flash curtain.

Vary the sequences with our remote controlled/programmable clock and create a living light show in your street! On special request.



# Joylight® curtains Led+ with slowflashes or static

177 - led+

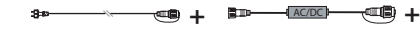

requires 230V power supply cable L: 1,50m FY08+ type... and bridge rectifier FY043+ type...

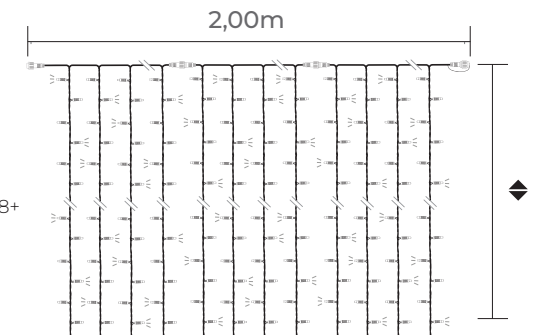

▶ with flash

◆	◀	LED	SLOWFLASH	P (W)	⌈	⌋	□	■
1.50m	2.00m	150 ○	60 ☉	13	15	27	FL74BF+	FL74F+
1.50m	2.00m	150 ●	60 ☉	13	15	27	FL74WBF+	FL74WF+
3.00m	2.00m	240 ○	120 ☉	25	15	18	FL70BF+	FL70F+
3.00m	2.00m	240 ●	120 ☉	25	15	18	FL70WBF+	FL70WF+
5.00m	2.00m	360 ○	180 ☉	60	15	9	FL75BF+	FL75F+
5.00m	2.00m	360 ●	180 ☉	60	15	9	FL75WBF+	FL75WF+
7.00m	2.00m	510 ○	240 ☉	60	15	9	FL72BF+	FL72F+
7.00m	2.00m	510 ●	240 ☉	60	15	9	FL72WBF+	FL72WF+
10.00m	2.00m	690 ○	360 ☉	69	15	9	FL79BF+	FL79F+
10.00m	2.00m	690 ●	360 ☉	69	15	9	FL79WBF+	FL79WF+

▶ static

◆	◀	LED	P (W)	⌈	⌋	□	■
1.50m	2.00m	210 ○	13	15	27	FL74-B+	FL74+
1.50m	2.00m	210 ●	13	15	27	FL74W-B+	FL74W+
3.00m	2.00m	360 ○	25	15	18	FL70-B+	FL70+
3.00m	2.00m	360 ●	25	15	18	FL70W-B+	FL70W+
5.00m	2.00m	540 ○	60	15	9	FL75-B+	FL75+
5.00m	2.00m	540 ●	60	15	9	FL75W-B+	FL75W+
7.00m	2.00m	750 ○	60	15	9	FL72-B+	FL72+
7.00m	2.00m	750 ●	60	15	9	FL72W-B+	FL72W+
10.00m	2.00m	1050 ○	69	15	9	FL79-B+	FL79+
10.00m	2.00m	1050 ●	69	15	9	FL79W-B+	FL79W+

accessories needed to operate these products

			□	■
1,50 m	230V power supply cable		FY08-B+	FY08+
0,30 m	bridge rectifier	690W max	FY043A-B+	FY043A+
0,20 m	bridge rectifier	230W max	FY041A-B+	FY041A+

**INNOVATION 2024**  
Our optimised LED+ :  
**-15% reduction**  
in consumption electrical  
(on average)  
**+brightness**

product info

- Blachere exclusive
- Registered design
- High brightness
- Shock resistant IK06
- Long lifespan
- Stable colour
- IP 66/69 protection rating. Maximum rating allowed for a 230V product
- Flexible connectivity thanks to the extensive Octoplus 230V by Blachere range.

**2 YEARS GUARANTEE**

conditions : contact us



## Joylight® Curtains with flash or static



### ▶ with flash

◆	◀	LED	FLASH	P (W)	⌈	⌋	□
0.80m	2.00m	140 ○	28 ○	14	14	30	<b>21CBFX</b>
0.80m	2.00m	140 ●	28 ○	14	14	30	<b>21CWBFX</b>
1.50m	2.00m	210 ○	30 ○	15	15	25	<b>24CBFX</b>
1.50m	2.00m	210 ●	30 ○	15	15	25	<b>24CWBFX</b>
1.50m	2.00m	210 ●	30 ○	15	15	25	<b>24CRFX</b>
1.50m	2.00m	210 ●	30 ○	15	15	25	<b>24CBLFX</b>
3.00m	2.00m	420 ○	56 ○	33	14	16	<b>20CBFX</b>
3.00m	2.00m	420 ●	56 ○	33	14	16	<b>20CWBFX</b>
3.00m	2.00m	420 ●	56 ○	33	14	16	<b>20CRFX</b>
3.00m	2.00m	420 ●	56 ○	33	14	16	<b>20CBLFX</b>
5.00m	2.00m	900 ○	90 ○	55	15	12	<b>25CBFX</b>
5.00m	2.00m	900 ●	90 ○	55	15	12	<b>25CWBFX</b>
5.00m	2.00m	900 ●	90 ○	55	15	12	<b>25CRFX</b>
5.00m	2.00m	900 ●	90 ○	55	15	12	<b>25CBLFX</b>
7.00m	2.00m	1200 ○	120 ○	80	15	8	<b>22CBFX</b>
7.00m	2.00m	1200 ●	120 ○	80	15	8	<b>22CWBFX</b>
10.00m	2.00m	1350 ○	135 ○	84	15	8	<b>29CBFX</b>
10.00m	2.00m	1350 ●	135 ○	84	15	8	<b>29CWBFX</b>

### ▶ static - high light density

◆	◀	LED	P (W)	⌈	⌋	□
1.50m	2.00m	342 ○	30	18	20	<b>24C-B</b>
1.50m	2.00m	342 ●	30	18	20	<b>24CW-B</b>
3.00m	2.00m	540 ○	35	18	15	<b>20C-B</b>
3.00m	2.00m	540 ●	35	18	15	<b>20CW-B</b>
5.00m	2.00m	900 ○	65	18	9	<b>25C-B</b>
5.00m	2.00m	900 ●	65	18	9	<b>25CW-B</b>
7.00m	2.00m	1080 ○	72	18	9	<b>22C-B</b>
7.00m	2.00m	1080 ●	72	18	9	<b>22CW-B</b>
10.00m	2.00m	1350 ○	58	18	10	<b>29C-B</b>
10.00m	2.00m	1350 ●	58	18	10	<b>29CW-B</b>

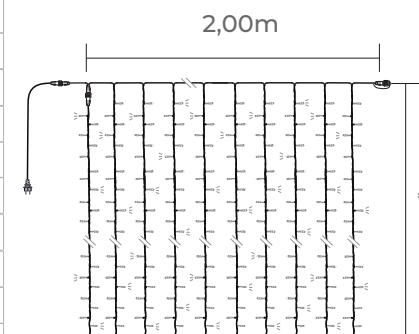

#### product info

Ideal for decorating facades, trees or for cross-street motifs.

Up to 30 curtains on the same power supply.

Compatible with the entire range.

Connection options with the Octoplus 230V by Blachere® accessories.



# ECO Led *curtains static*

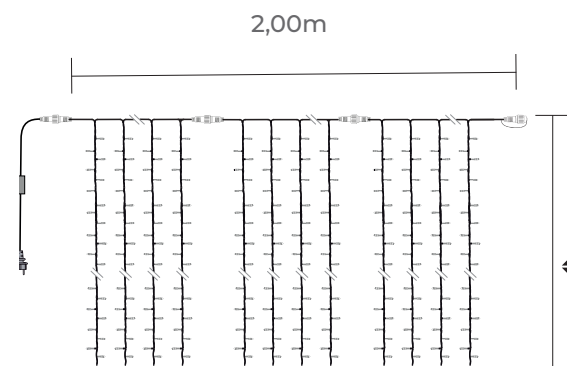

◆	◀	LED	P (W)	□	⏏	□
1.50m	2.00m	210 ○	15	15	20	<b>ECO24-B</b>
1.50m	2.00m	210 ●	15	15	20	<b>ECO24W-B</b>
3.00m	2.00m	360 ○	20	15	15	<b>ECO20-B</b>
3.00m	2.00m	360 ●	20	15	15	<b>ECO20W-B</b>
5.00m	2.00m	576 ○	30	16	12	<b>ECO25-B</b>
5.00m	2.00m	576 ●	30	16	12	<b>ECO25W-B</b>
7.00m	2.00m	750 ○	50	15	7	<b>ECO22-B</b>
7.00m	2.00m	750 ●	50	15	7	<b>ECO22W-B</b>
10.00m	2.00m	1050 ○	55	15	6	<b>ECO29-B</b>
10.00m	2.00m	1050 ●	55	15	6	<b>ECO29W-B</b>

product info

**Unbeatable value for money with proven reliability.**

**NEW: Octoplus 230V by Blachere connection system**

An extensive selection of accessories and connection options with Octoplus® 230V by Blachere® accessories.

# Joylight® 24V curtains with flash

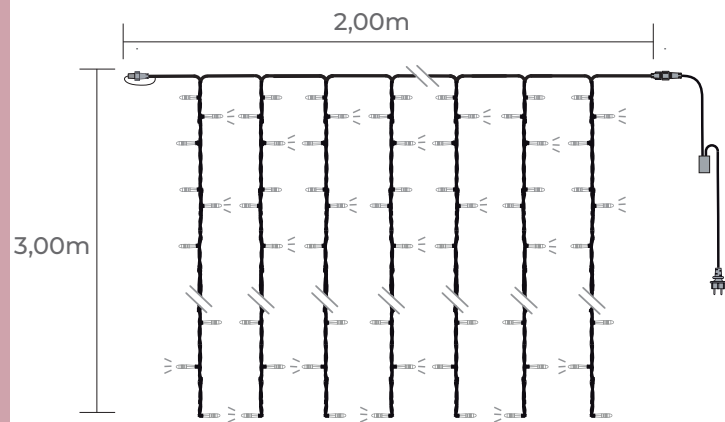

◆	◀	LED	F.	P (W)	⌘	Ⓜ	□
3.00m	2.00m	300 ○	60 ◉	12.5	15	2	<b>FL203-FX</b>
3.00m	2.00m	300 ●	60 ◉	12.5	15	2	<b>FL203W-FX</b>
3.00m	2.00m	300 ●	60 ◉	12.5	15	2	<b>FL203B-FX</b>
3.00m	2.00m	300 ●	60 ◉	12.5	15	2	<b>FL203R-FX</b>
3.00m	2.00m	300 ●	60 ◉	12.5	15	2	<b>FL203P-FX</b>



# Joylight® Slowglow curtains



2,00 m

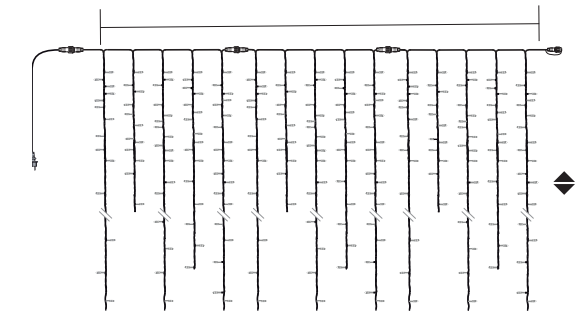

**product info**

New animation exclusive to Blachere Illumination. Gentle lighting snowflake effect.

Compatible with the entire range.

Connection options with 230V Octoplus® accessories by Blachere®

◆	◀	LED Slowglow	P (W)	⌘	Ⓜ	□
1.50m	2.00m	120 ○	16	15	13	<b>24SC</b>
1.50m	2.00m	120 ●	16	15	13	<b>24WSG</b>
3.00m	2.00m	180 ○	15	15	12	<b>20SC</b>
3.00m	2.00m	180 ●	15	15	12	<b>20WSG</b>
5.00m	2.00m	210 ○	17	15	12	<b>25SC</b>
5.00m	2.00m	210 ●	17	15	12	<b>25WSG</b>
7.00m	2.00m	225 ○	17	15	12	<b>22SC</b>
7.00m	2.00m	225 ●	17	15	12	<b>22WSG</b>
10.00m	2.00m	270 ○	15	15	13	<b>29SC</b>
10.00m	2.00m	270 ●	15	15	13	<b>29WSG</b>



# “Scintillance” curtains

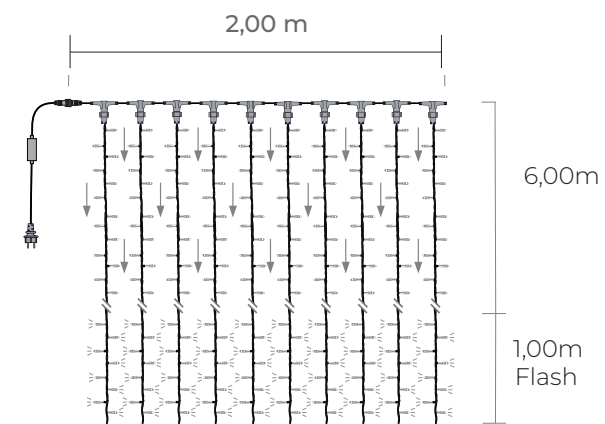

◆	◆	LED	FLASH	P (W)		☑	☐
7,00m	2,00m	420 ●	80 ☼	55	10	-	ECO216W

### product info

Recreate the most beautiful avenue in the world wherever you are!

Product and animation developed exclusively for the Champs Elysées now available for all our customers.

Blachere illumination official supplier of the « Champs Elysées » Committee.

A PRO version that exactly reproduces the effect on the Champs Elysées and an ECO version with a simplified effect.



# Duo Colors® Stalactites with flash

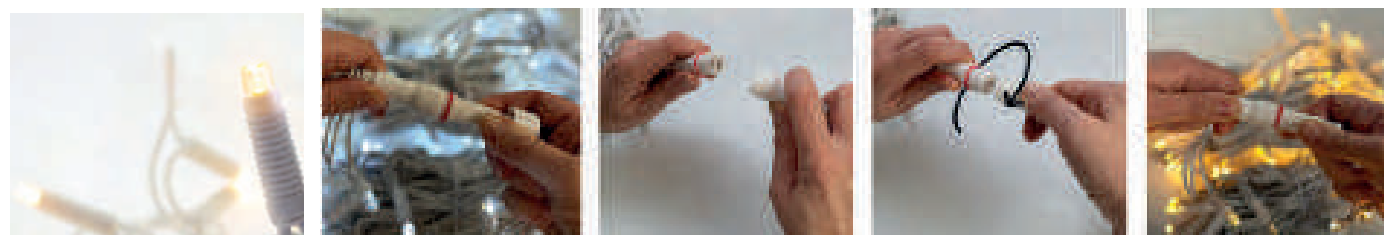

4,50m

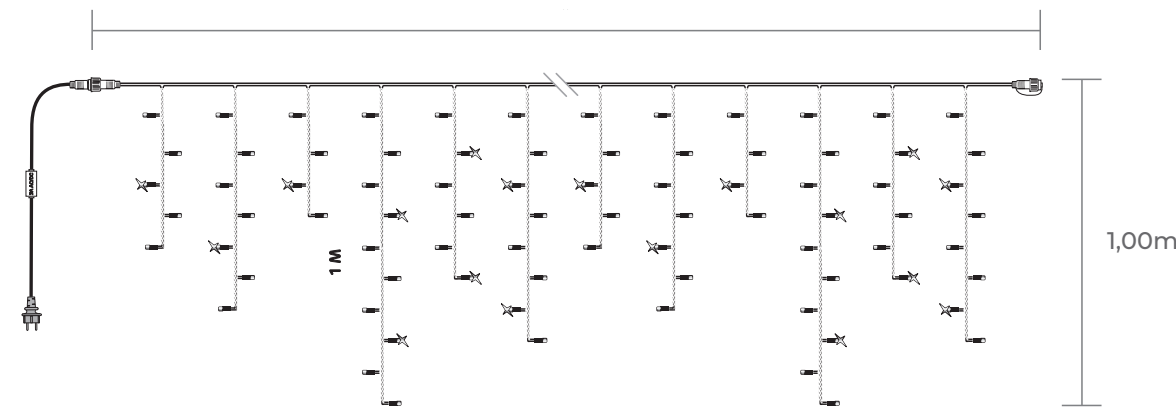

1,00m

product info

**2 products in 1!**  
Your garland can be either warm white or pure white. Reverse the connection to obtain pure white/pure white flash or warm white/warm white flash. See DUO COLORS® Decor Collection p 32-33).

◆	◆	LED	SLOWFLASH	P (W)	⏏	📶	□
1.00m	4.50m	180	60	15	36	15	330BWWF





# Stalactitlight® Led+ with slowflash or static



requires 230V power supply cable L: 1,50m FY08+ type... and bridge rectifier FY043+ type...

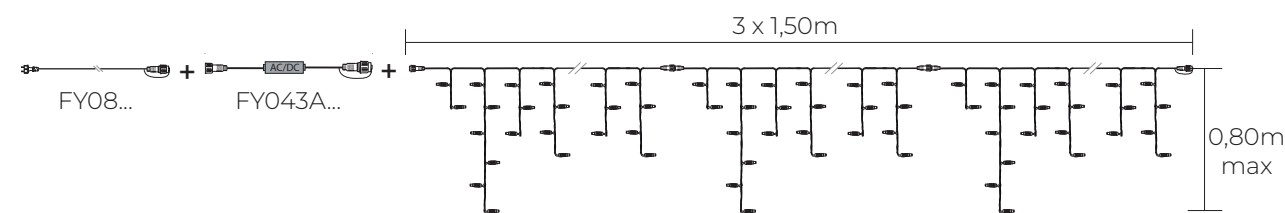

▶ with slowflash

◆	◀	LED	SLOWFLASH	P (W)	⌌	⌌	□
0.80m	4.50m	120 ○	60 ⚙	13	48	20	<b>FL390BF+</b>
0.80m	4.50m	120 ●	60 ⚙	13	48	20	<b>FL390WBF+</b>

▶ static

◆	◀	LED	P (W)	⌌	⌌	□
0.80m	4.50m	180 ○	13	48	20	<b>FL390-B+</b>
0.80m	4.50m	180 ●	13	48	20	<b>FL390W-B+</b>

accessories needed to operate these products

			□	■
1,50 m	230V power supply cable		FY08-B+	FY08+
0,30 m	bridge rectifier	690W max	FY043A-B+	FY043A+
0,20 m	bridge rectifier	230W max	FY041A-B+	FY041A+

**INNOVATION 2024**  
Our optimised LED+ :  
**-15% reduction**  
in consumption electrical  
(on average)  
**+brightness**

product info

Blachere exclusive  
- Registered design  
- High brightness  
- Shock resistant IK06  
- Long lifespan  
- Stable colour  
- IP 66/69 protection rating.  
Maximum rating allowed for a 230V product  
- Flexible connectivity thanks to the extensive Octoplus 230V by Blachere range.

**2 YEARS GUARANTEE**

conditions : contact us



# Stalactitlight® with flash or static

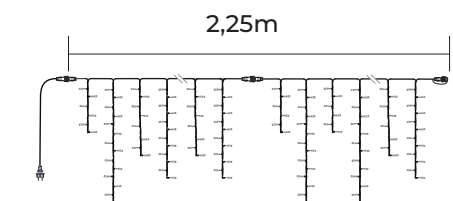
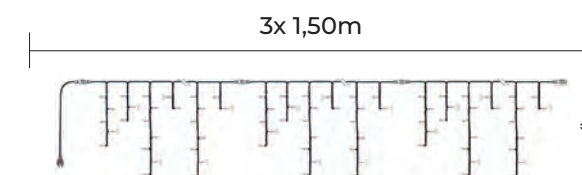

352-FX / 352W-FX / 352R-FX / 352B-FX / 354-FX  
354W-FX / 352 / 352W / 354 / 354W

353C / 353CW

▶ with flash

◆	◀	LED	FLASH	P (W)	⏏	🔌	□
0.60m	4.50m	156 ○	48 ⦿	10	48	15	<b>352-FX</b>
0.60m	4.50m	156 ●	48 ⦿	10	48	15	<b>352W-FX</b>
0.60m	4.50m	156 ●	48 ⦿	10	48	15	<b>352R-FX</b>
0.60m	4.50m	156 ●	48 ⦿	10	48	15	<b>352B-FX</b>
1.00m	4.50m	180 ○	60 ⦿	10	36	15	<b>354-FX</b>
1.00m	4.50m	180 ●	60 ⦿	10	36	15	<b>354W-FX</b>

▶ static

◆	◀	LED	P (W)	⏏	🔌	□
0.60m	4.50m	180 ○	10	48	15	<b>352</b>
0.60m	4.50m	180 ●	10	48	15	<b>352W</b>
1.00m	4.50m	240 ○	12	36	15	<b>354</b>
1.00m	4.50m	240 ●	12	36	15	<b>354W</b>
1.50m	4.50m	320 ○	16	32	15	<b>353C</b>
1.50m	4.50m	320 ●	16	32	15	<b>353CW</b>

product info

An absolute must since its creation, this product is a best-seller owing to its reliability. Can be divided into sections for greater adaptability.

Compatible with the entire range.

Connection options with 230V Octoplus® accessories by Blachere®.

# Ceilings with flash or static

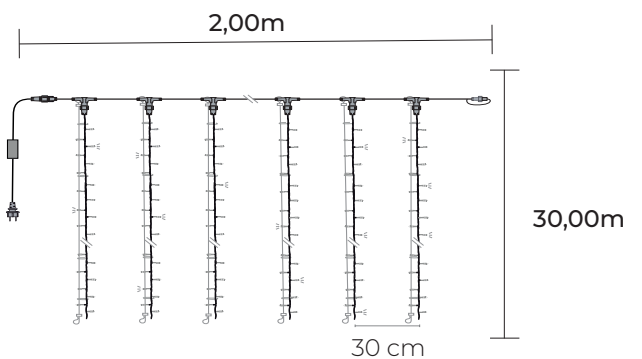

► with flash

◆	◆	LED	F.	P (W)	⌈	⌋	■
30,00m	2,00m	588 ○	98 ⚙	30	7	3	414-FX
30,00m	2,00m	588 ●	98 ⚙	30	7	3	414W-FX

► static

◆	◆	LED	P (W)	⌈	⌋	■
30,00m	2,00m	686 ○	30	7	3	414
30,00m	2,00m	686 ●	30	7	3	414W



# Micro light+ PRO® ceilings

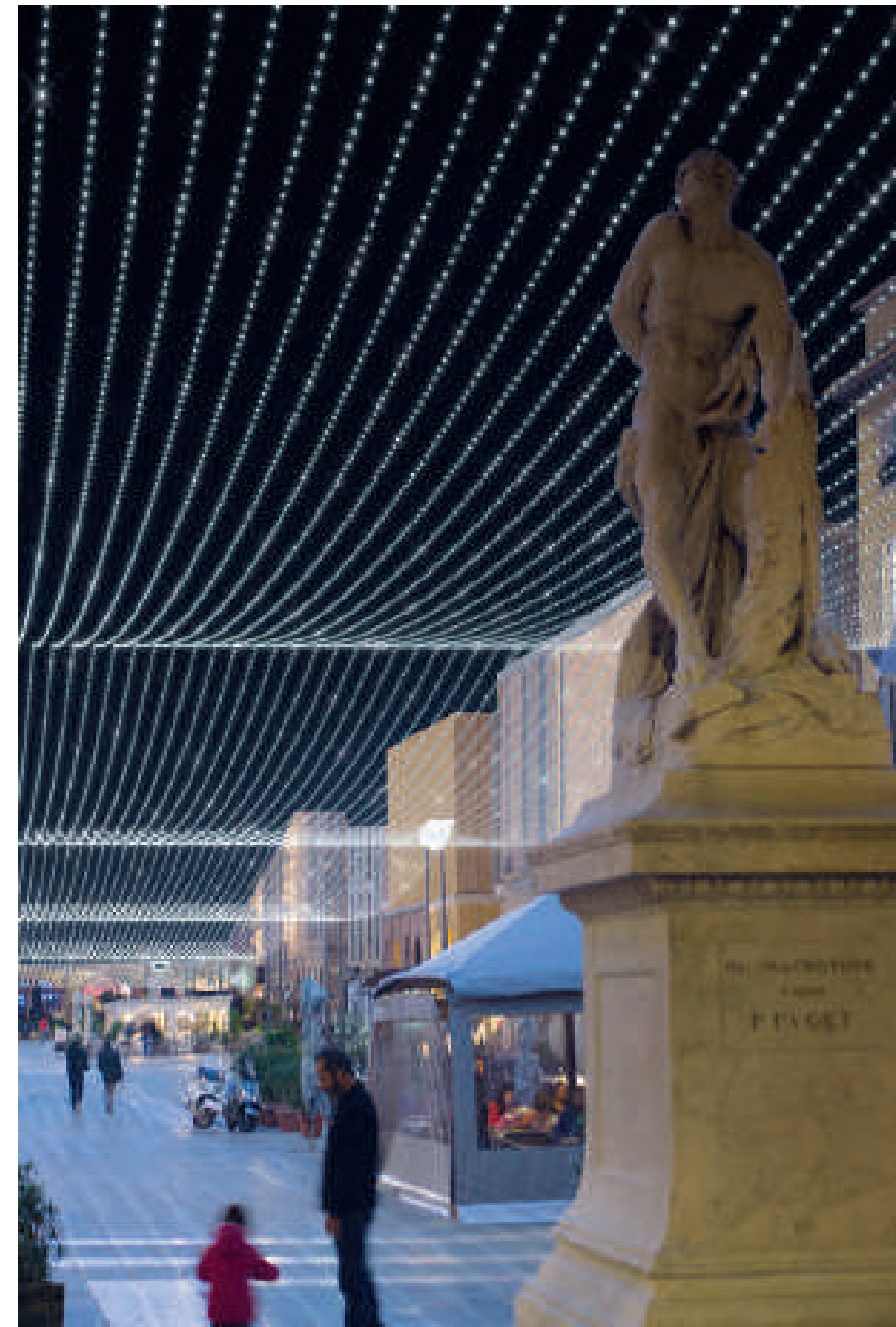
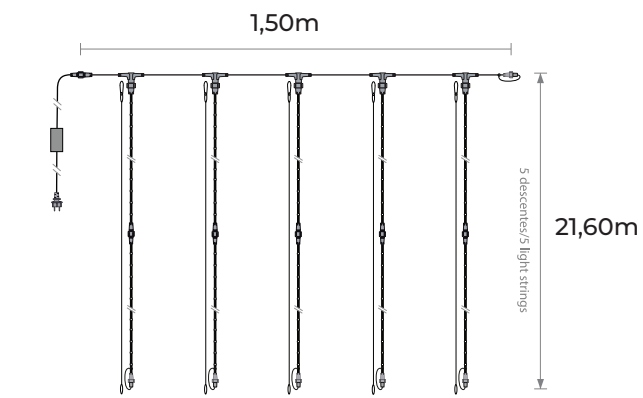

► ceilings Micro light + PRO

◆	◆	LED	P (W)	⌋	⌈	⊠
1,50m	21,60m	720 ○	36	5	2	420+
1,50m	21,60m	720 ●	36	5	2	420W+



## Duo Colors® Braids *with flashes*

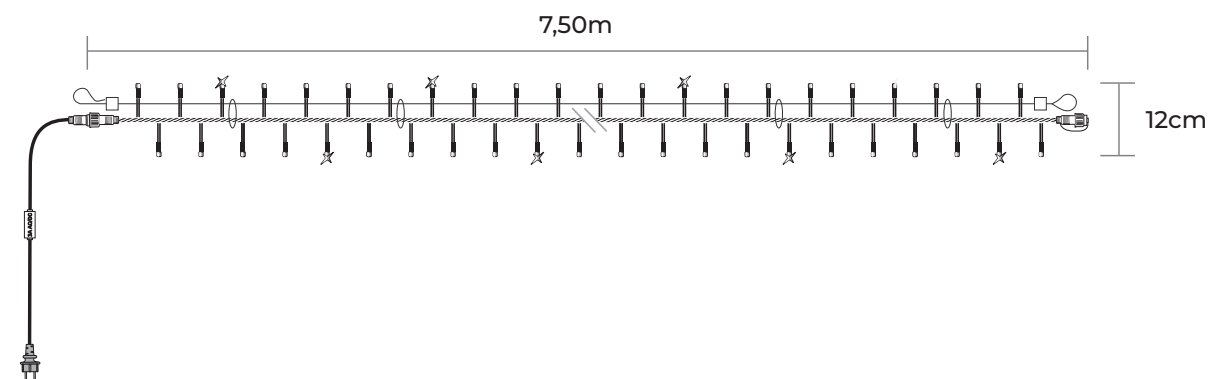
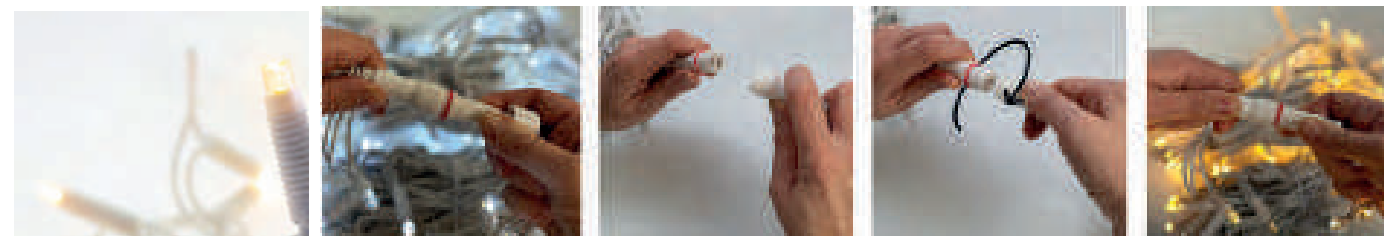

product info

**2 products in 1!**  
Your garland can be either warm white or pure white. Reverse the connection to obtain pure white/pure white flash or warm white/warm white flash. See DUO COLORS® Decor Collection p 32-33).

◆	LED	FLASH	P (W)	🔌	∅	□
7.50m	180	60	12	10	12cm	TSL4WWF



## LED+ Braided Garlands *with flash*

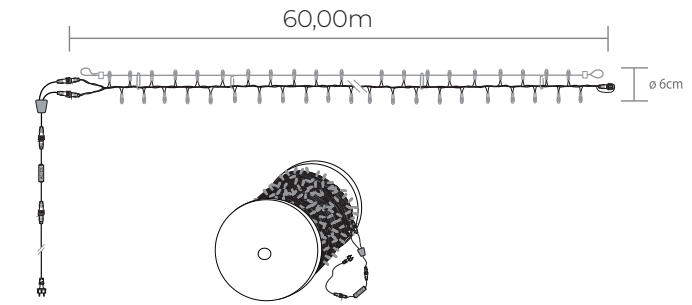

micro steel wire

### ▶ with flash

◀	∅	LED	FLASH	P (W)	☑	□
60.00m	6cm	648 ○	312 ◉	60	2	<b>TSL60+</b>
60.00m	6cm	648 ●	312 ◉	60	2	<b>TSL60W+</b>

Product delivered with power supply kit + rectifier and 60m roll.

## Braided garlands *with flash or static*

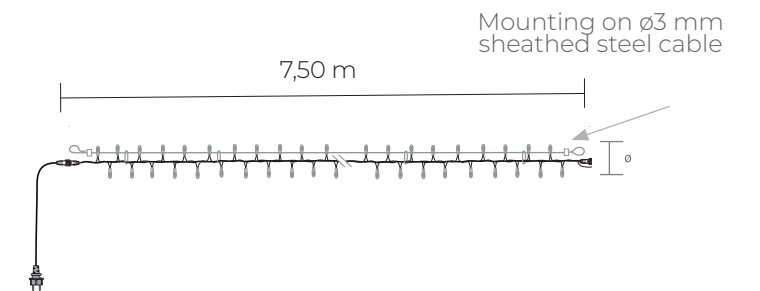

### ▶ with flash

◀	∅	LED	FLASH	P (W)	☑	□
7.50m	12cm	210 ○	30 ◉	13	13	<b>TSL3FX</b>
7.50m	12cm	210 ●	30 ◉	13	13	<b>TSL3WFX</b>

### ▶ static

◀	∅	LED	P (W)	☑	□
7.50m	6cm	240 ○	13	13	<b>TSL2</b>
7.50m	6cm	240 ●	13	13	<b>TSL2W</b>

## Nicia® garlands with flash

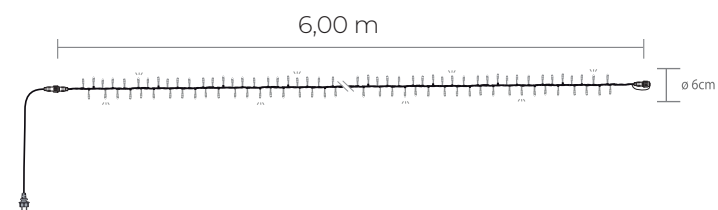

◀	∅	LED	FLASH	P (W)	📏	□
6.00m	6cm	432 ◯	48 ⦿	23	9	558-FX
6.00m	6cm	432 ●	48 ⦿	23	9	558W-FX



## Nicia® garlands X-Led effect

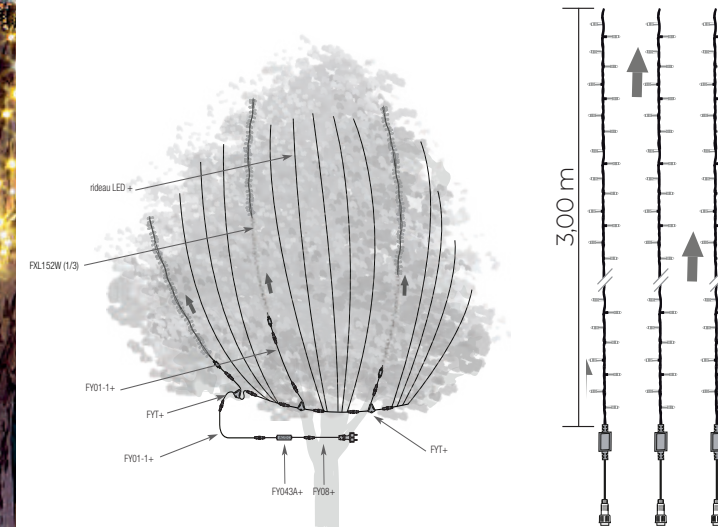

▶ Set of 3 garlands

◀	LED	P (W) x1	■	□
3.00m	152 ●	9	FXL152	FXL152-B

N

# Scrolling braid *two-colour*

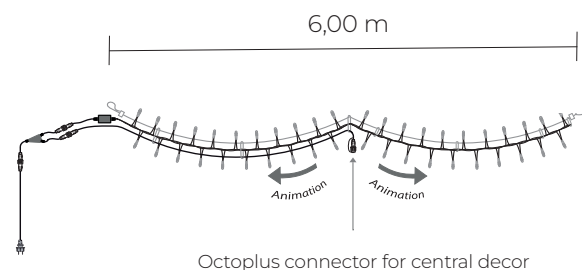

◆	LED	P (W)	☑	□
6.00m	240 ●●	55	-	TSLBL-W
6.00m	240 ●●	55	-	TSLWW-W



# Garland with 10 glittering candles *flame effect*

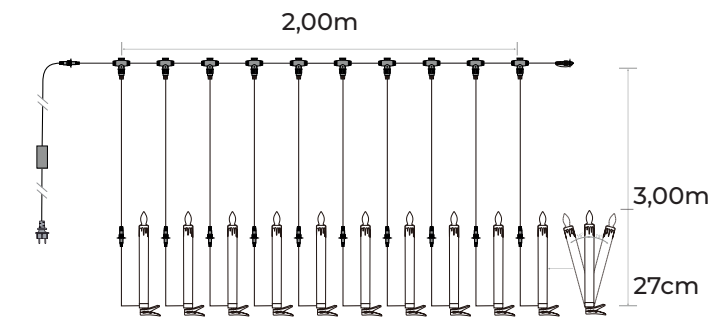
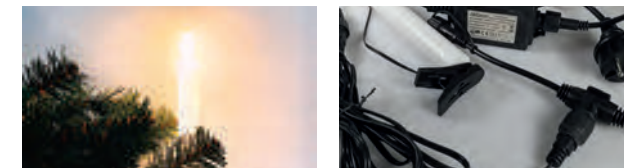

◆	◆	LED	P (W)	☑	☑	■
2.00m	3.00m	●	12	10	2	FL910B

**product info**

Very beautiful and realistic candles garland thanks to its wax effect and a delicate and gleaming light diffusion.

Easy to install on the twigs of your tree thanks to its integrated clip.

# Multicoloured Cherrylight® Garland

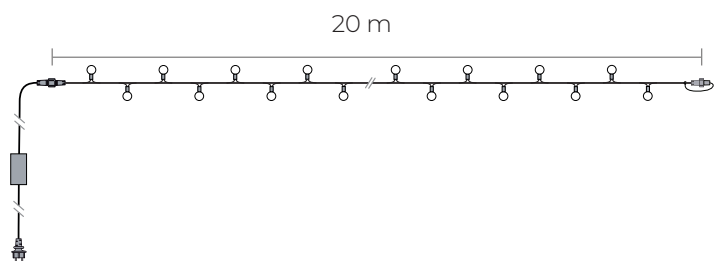

◀	LED	P (W)	🔌	■
20.00m	160	4	3	FL555C



# Multicoloured Cherrylight® curtains

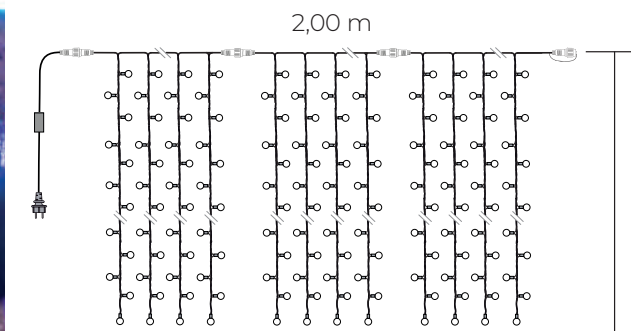

◀	▶	LED	P (W)	🔌	■
2.00m	1.50m	180	15	15	FL224C
2.00m	3.00m	300	25	10	FL220C







# Bunch Light® RGBWW Bouquets

*Create a magnificent multicoloured field of light!*

N



KBRGBWW

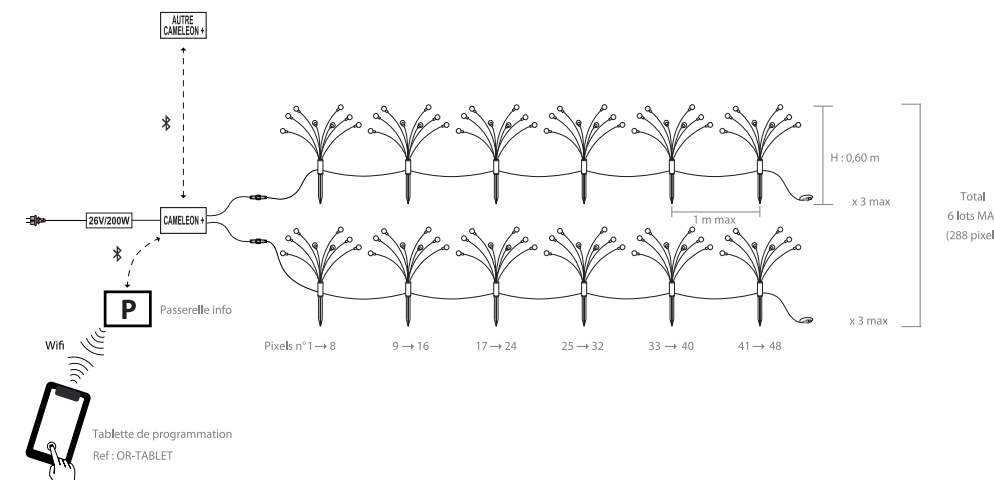

Our new Bunch Light® RGBWW Bouquets can be placed on the ground to create animated and multicoloured luminous surface. they can be customised to create an overall lighting design. Each lighting pearl can be controlled like a pixel to create a multicoloured field of light. The rods are flexible and move with the wind, making a lively and poetic show.

This product is sold per set of 6 bouquets, each made up of 8 RGBWW lighting pearl. For any customised project, please contact your account manager.



# Hanging bouquets indoor & outdoor

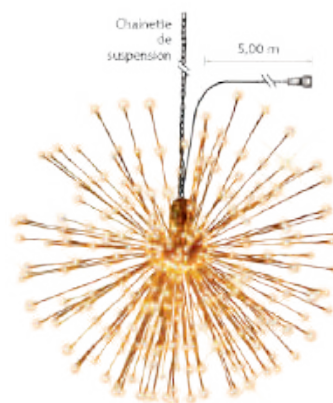

drawing of installation:

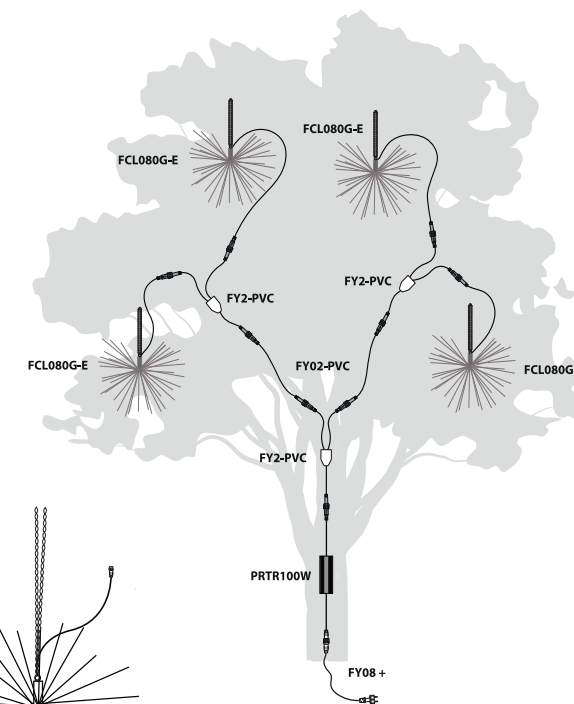
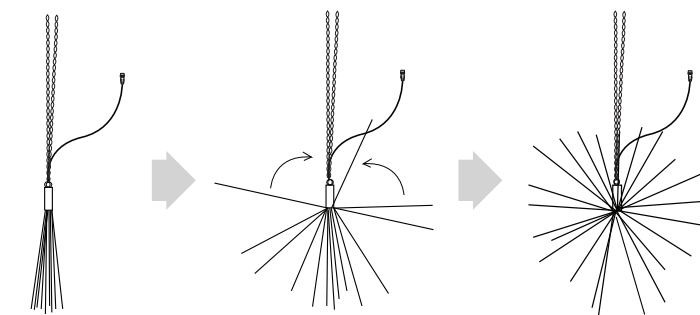

► Indoor use



∅	Colour	LED	FLASH	P (W)	
0,80 m	Silver	441 ○	63 ○	18	<b>FCL080A</b>
0,80 m	Gold	441 ●	63 ○	18	<b>FCL080C</b>
Indoor transformer for FCL bouquet - sold separately				25	<b>PRTR24VI</b>

► Outdoor use



∅	Colour	LED	FLASH	P (W)	
0,80 m	Silver	441 ○	63 ○	18	<b>FCL080A-E</b>
0,80 m	Gold	441 ●	63 ○	18	<b>FCL080C-E</b>
Outdoor transformer for FCL bouquet - sold separately				25	<b>PRTR24V</b>

product info

The hanging bouquets animated with flash with a gold or silver decoration, good daytime effect.  
**Working with a PRTR24VI or PRTR24V transformer - sold separately.**  
**Compatible with 24V Octoplus extension leads.**

# Xled® hanging motifs

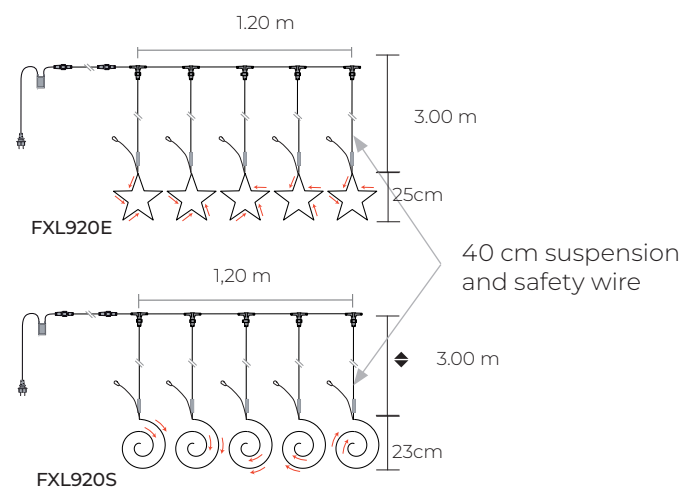

► set of 5 decorations

◆	◀	decorations	LED SMD	P (W)	■
3,00 m	1,20m	∅ 25 cm	270 ○	25	<b>FXL920E</b>
3,00 m	1,20m	23 x 20 cm	270 ○	25	<b>FXL920S</b>



# X-Led® sparkling stars

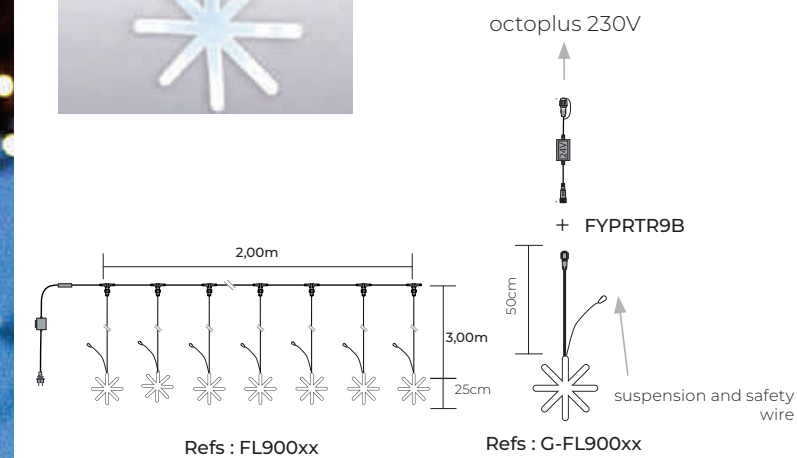

► set of 10 stars

◆	◀	∅	2D LED stars	LED	P (W)	■
3,00 m	2,00m	25cm	10 ○	250	18	<b>FL900E</b>
3,00 m	2,00m	25cm	10 ●	250	18	<b>FL900EW</b>
3,00 m	2,00m	25cm	10 ●○	250	18	<b>FL900EWW</b>
3,00 m	2,00m	25cm	10 ●●●●	250	18	<b>FL900EM</b>

► individual stars

	2D LED stars	LED	P (W)	□
12D sparkling star ∅25cm connected on FYPRT9 only (not supplied)	1 ○	25	3	<b>G-FL900</b>
12D sparkling star ∅25cm connected on FYPRT9 only (not supplied)	1 ●○	25	3	<b>G-FL900WW</b>
230V -> 24V transformer with Octoplus connector				<b>FYPRT9B</b>



# Hanging balls with flame effect

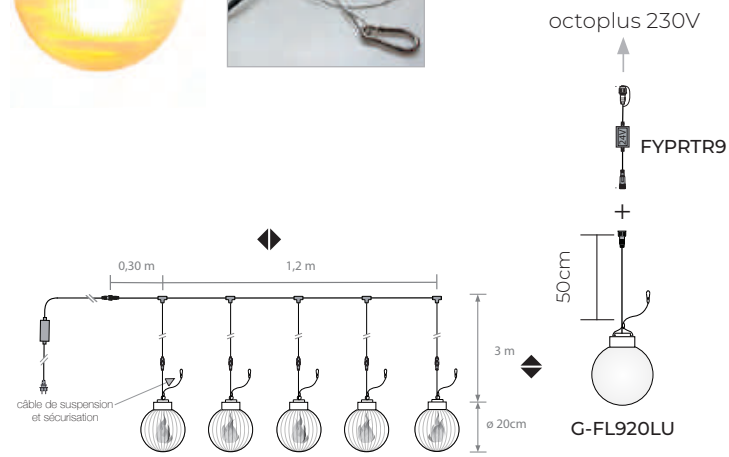

► set of 5 spheres

◆	◀	animation	🕒	P (W)	■
3,00 m	1.20m	glittering	5 🟡 ø 20 cm	18	<b>FL920LU</b>

► individual sphere

1 ball ø20cm - to connect on FYPRTR9 only	1 🟡 ø 20 cm	3	<b>G-FL920LU</b>
230V -> 24V transformer with Octoplus connector			<b>FYPRTR9</b>



# Hanging balls with animations

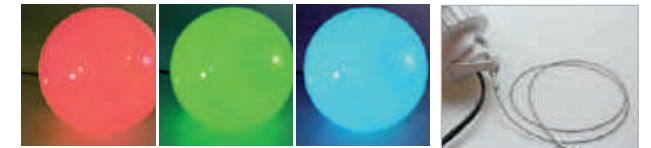

FL920M / G-FL920M  
Random and unsynchronized colour change

60 cm suspension and safety wire

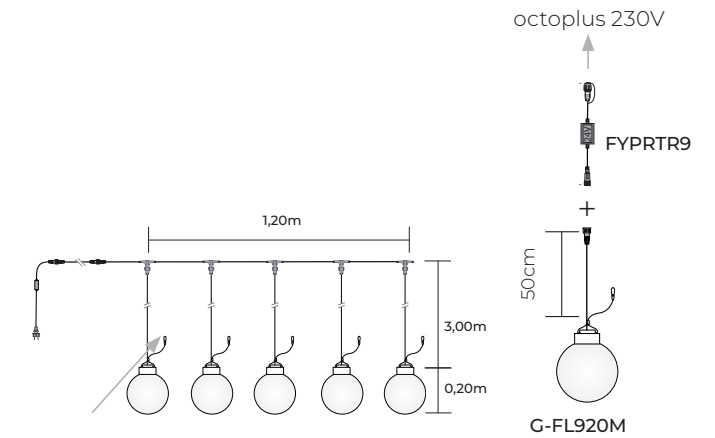

► set of 5 spheres

◆	◀	animation	🕒	P (W)	■
3,00 m	1.20m	RGB	5 RGB ø 20 cm	24	<b>FL920M</b>

► individual sphere

1 ball ø20cm - to connect on FYPRTR9 only	1 RGB ø 20 cm	5W	<b>G-FL920M</b>
230V -> 24V transformer with Octoplus connector			<b>FYPRTR9</b>



# Bulbs

## Nostalgia XL



60 cm suspension and safety wire

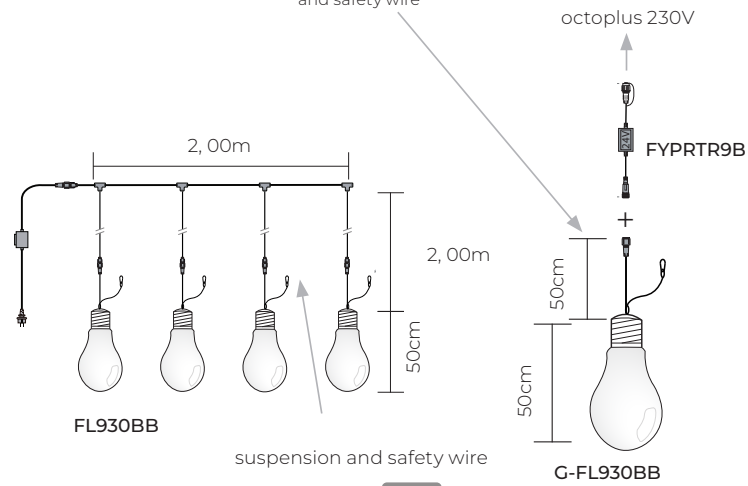

▶ set of 4 bulbs

◆	◀▶	💡	micro LED	FLASH	P (W)	■
2,00 m	2,00 m	∅28 cm - H 50 cm	400 ●	200	18	FL930BB

▶ individual bulb

			micro LED	FLASH	P (W)	□
1 bulb - connection on FYPRT9B only (not supplied)			100 ●	50 ●	4	G-FL930BB
230V -> 24V transformer with Octoplus connector						FYPRT9B



# Stalactite

## Nostalgia by Blachere®

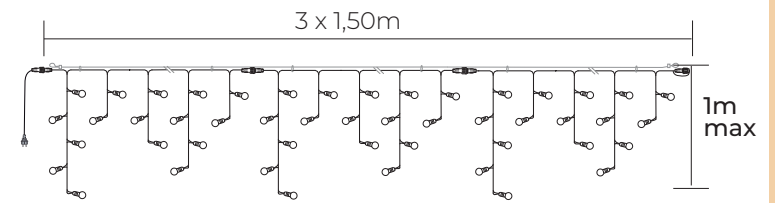

FL361W

▶ stalactite

◆	◀▶	LED	💡	P (W)	⌌	🔌	□
1,00 m	4,50 m	48 ●	48	20	15	12	FL361W

# Decorative Hanging spheres

N

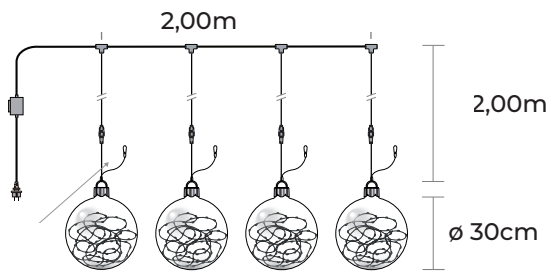

► set of 4 spheres

◆	◆	💡	micro LED	FLASH	P (W)	■
2,00 m	2,00m	ø30cm	400 🟡	200 🟡	18	FL930A



# Tree net honeycomb light

N

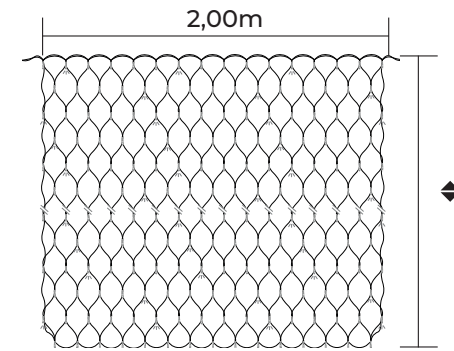

### product info

This net makes easy the decoration of tree trunks... with light. Thanks to its honeycomb mesh, it is placed around the trunk and adjusted to the diameter.  
Ergonomic and practical, it will take you on average 10 times less time to dress your tree trunks than with a traditional garland!  
The colour of the cable (brown) allows it to be less visible during the day and is exclusive to Blachere Illumination.

◆	◆	LED	FLASH	P(W)	🔌	■
2,00m	2,00m	204 🟡	52 🟡	11	7	802W-F
2,00m	3,00m	306 🟡	78 🟡	16	5	803W-F

# X-Led® stems

## Double drop double-sided

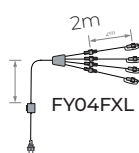
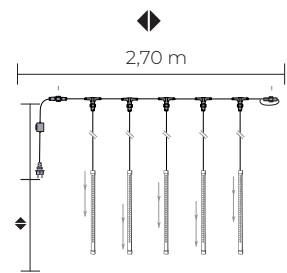

FXL08-B22

Suspension attachment and securing required during installation

◆	◆	LED	P (W)	⏏	🔌	■
0,50 m	2,70m	320 ○	12	5	2	<b>FXL055</b>
0,80 m	2,70m	480 ○	17	5	2	<b>FXL085</b>

X-Led stem for B22/230V socket FY03B22 accessories

◆	LED	P (W)	■
0,80 m	96 ○	2	<b>FXL08-B22</b>
Multi ends power supply			<b>FY04FXL</b>



**product info**

A smooth double-drop animation, exclusive to Blachere, registered design, bringing success to the brand especially with the Champs Elysées project.

Double-sided stems for 360 degree brightness. Multiple uses on facades, crosstreet motifs or tree decorations.

Multi-output accessory FY04FXL : 20 stems on a single power supply !



# Light stems with flash

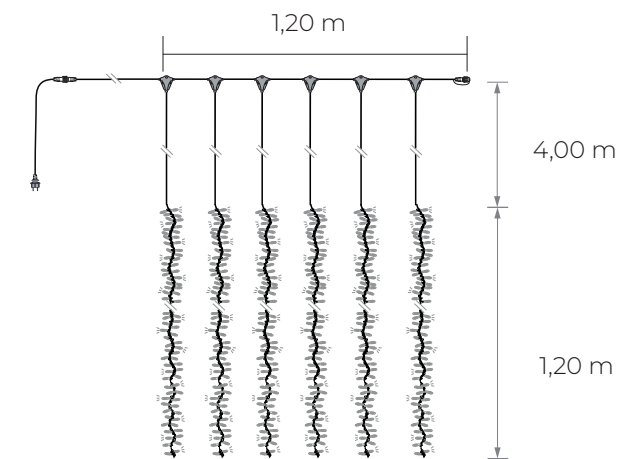

**product info**

Very light weight products that can be suspended from all kinds of branches.

Set of 6 suspensions.

◆	◆	LED	FLASH	P (W)	⏏	🔌	■
1,20m	1,20m	480 ○	120 ⚙	50	6	3	<b>950-FX</b>
1,20m	1,20m	480 ●	120 ⚙	50	6	3	<b>950W-FX</b>



# Branches *Micro Led*

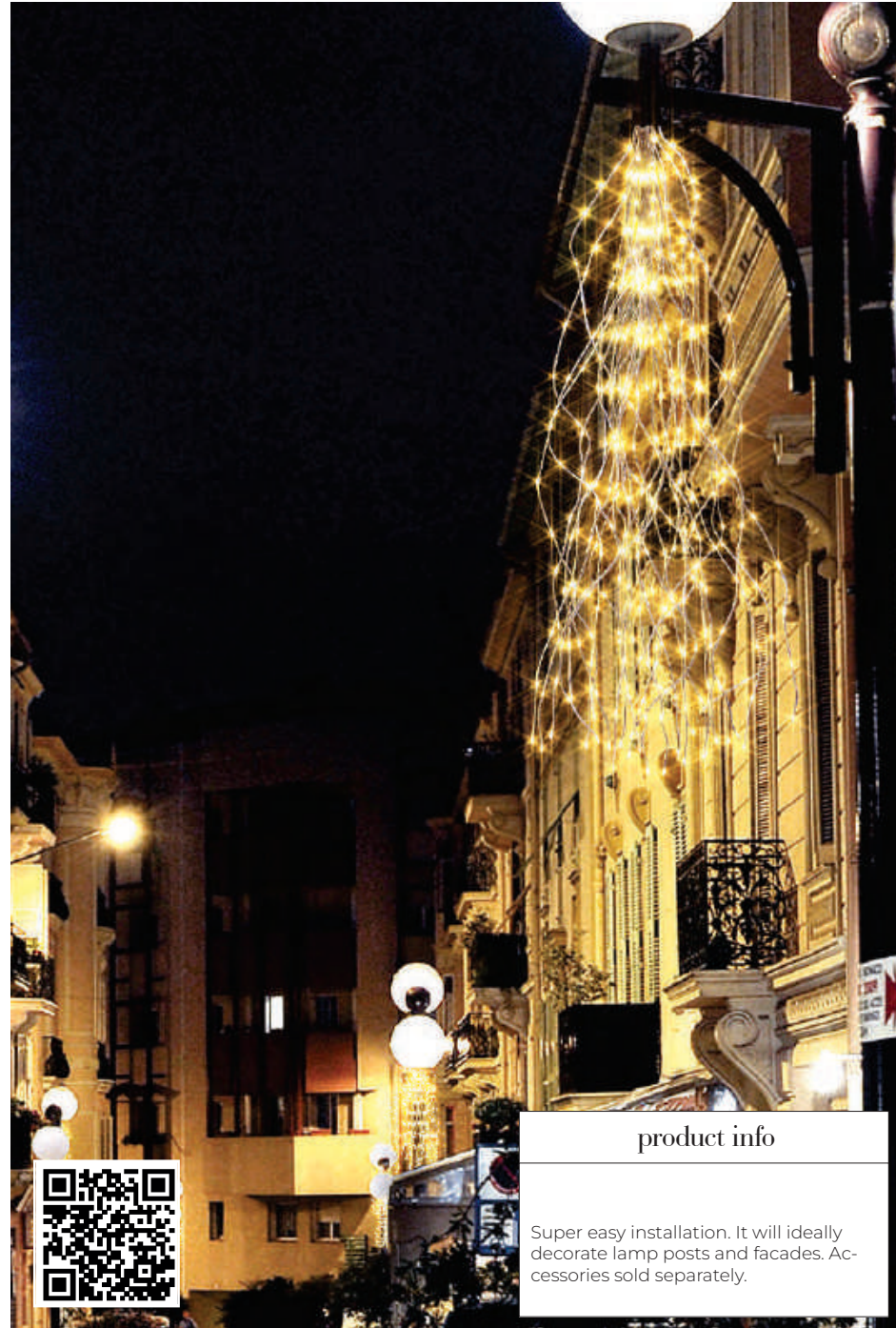
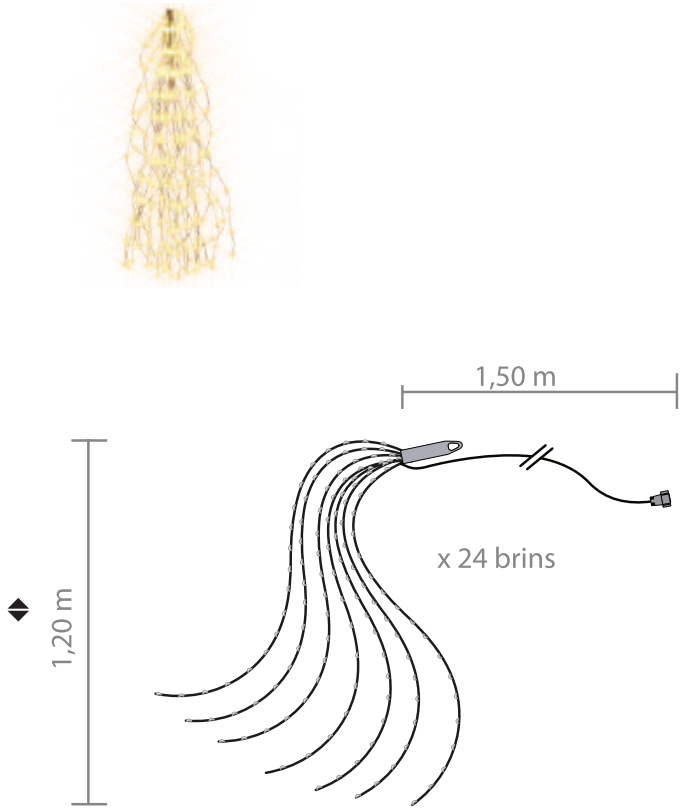

**product info**

Super easy installation. It will ideally decorate lamp posts and facades. Accessories sold separately.

◆	LED	P (W)	⏏	📏	📦
1.20m	288 ○	6	24	4	<b>BRIN288</b>
1.20m	288 ●	6	24	4	<b>BRIN288W</b>
extension cable 2m					<b>FY04W-PVC</b>
switch mode power supply 24V dc-25W					<b>PRTR24V</b>

# Twigs *Multi-motifs*

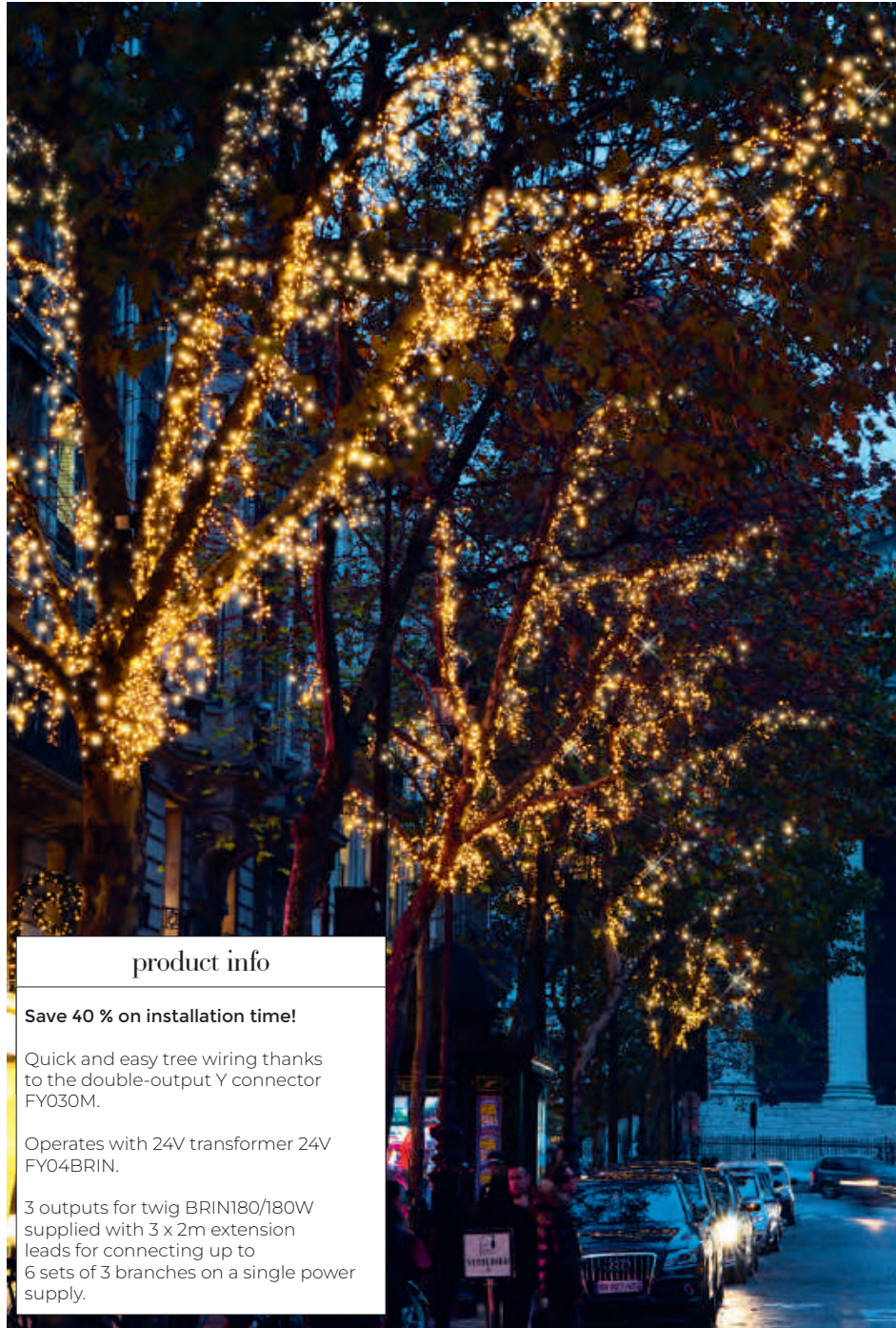
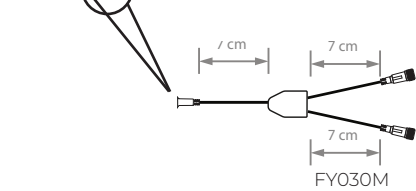

**product info**

Save 40 % on installation time!

Quick and easy tree wiring thanks to the double-output Y connector FY030M.

Operates with 24V transformer 24V FY04BRIN.

3 outputs for twig BRIN180/180W supplied with 3 x 2m extension leads for connecting up to 6 sets of 3 branches on a single power supply.

► set of 3 twigs

◆	LED	P (W)	■
3x1.80m	3x161 ○	3x5	<b>BRIN180</b>
3x1.80m	3x161 ●	3x5	<b>BRIN180W</b>
24V - 3 output transformer for BRIN180/180W			<b>FY04BRIN</b>
double output Y connector			<b>FY030M</b>



## Foldable *suspensions*

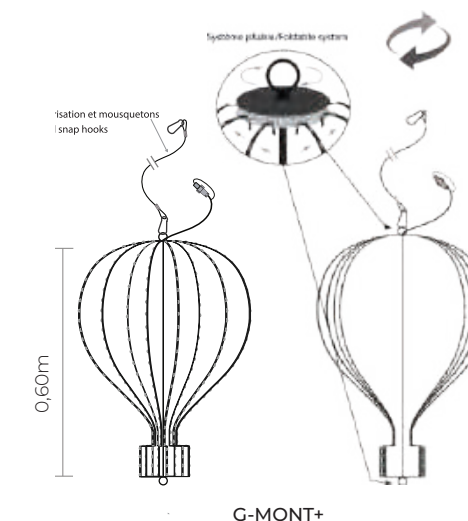
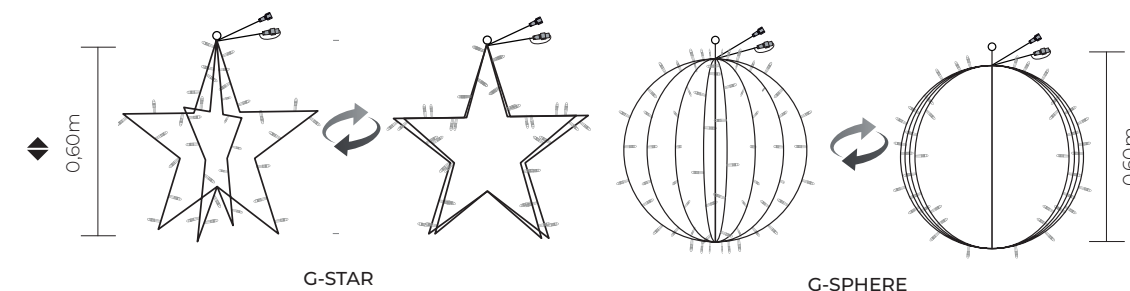

- Led Classic compatible with OctoPlus 230V range  
requires 230V power supply cable L: 1,50m FY08+ type...  
and bridge rectifier FY043+ type...



◆	∅	LED	FLASH	P (W)	□
0.60m	0.60m	70 ○	6 ⦿	4	<b>G-SPHERE</b>
0.60m	0.60m	41 ○	4 ⦿	4	<b>G-STAR</b>

- Micro light + PRO compatible with OctoPlus 24V range



◆	∅	LED	P (W)	□
0.60m	0.60m	144 ○	12	<b>G-SPHER+</b>
0.60m	0.60m	144 ●	12	<b>G-SPHERW+</b>
0.60m	0.60m	88 ○	10	<b>G-STAR+</b>
0.60m	0.60m	88 ●	10	<b>G-STARW+</b>
0.60m	0.60m	136 ○	12	<b>G-MONT+</b>
0.60m	0.60m	136 ●	12	<b>G-MONTW+</b>

compatible with PRTR24V or OCTOPLUS 24V accessories

### product info

These foldable suspensions are aesthetic by day thanks to the white lacquering of the metal structures (available in Led Classic or Micro light + PRO). Power supply sold separately.

Compatible with the entire range.



# Spherical suspensions *foldable*



DKOB50W

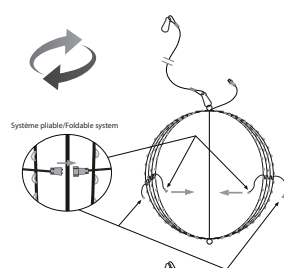
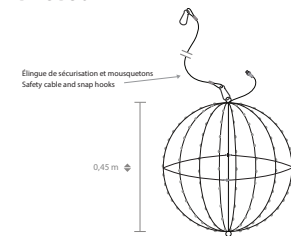

DKOB80W

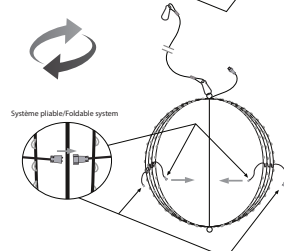
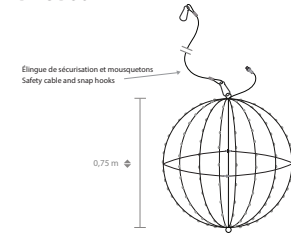

Ø	LED	FLASH	P (W)	⚡
0.45m	212	108	10	<b>DKOB50W</b>
0.75m	400	200	15	<b>DKOB80W</b>
indoor transformer (sold separately)				<b>PRTR24VI</b>



**MAISON DU CHOCOLAT**  
PARIS

# Ledmosphere *garlands*

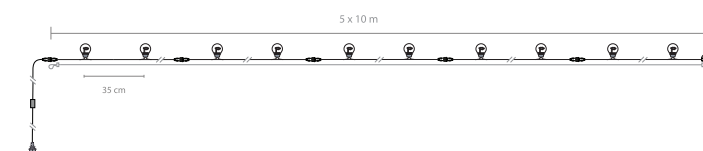

### product info

New garland packaged in rolls and mounted on a steel wire which will allow an easy installation and a greater resistance. Compatible with the Octoplus 230V range. Carabiners supplied.

◀▶	💡	P (W)	🔌	■
10.00m	30	14	10	<b>600W</b>
50.00m	150	70	2	<b>650W</b>



## Garlands with B22 sockets



### product info

Customise your garland with different bulbs suggested on p239 and make up your own eye-catching effect.

Replace your old incandescent bulbs with LED bulbs, new technology with vintage look but more economical so more ecological.

### ▶ Rolls of B22 socket garlands - plug not included

◆	description	cable section	B22	B22	B22
100.00m	roll of garland 1 socket/m	2 x 1,5 mm <sup>2</sup>	■ G098C	■ G098CN	
100.00m	roll of garland 2 sockets/m	2 x 1,5 mm <sup>2</sup>	■ G099C	■ G099N	
100.00m	roll of garland 3 sockets/m	2 x 1,5 mm <sup>2</sup>	■ G100C	■ G100CN	
50.00m	roll of garland 4 sockets/m	2 x 1,5 mm <sup>2</sup>	■ G112C	■ G112CN	
50.00m	roll of garland 5 sockets/m	2 x 1,5 mm <sup>2</sup>	■ G113C		
100.00m	roll of garland 3 sockets/m	2 x 1,5 mm <sup>2</sup>			□ G100C-B

### ▶ garlands with B22 sockets - plug included

◆	description	cable section	B22	B22
9.00m	garland of 20 sockets	2 x 1,5 mm <sup>2</sup>	■ G1C	■ G1CN
15.00m	garland of 40 sockets	2 x 1,5 mm <sup>2</sup>	■ G2C	

# Bulbs

## *B22 & E27 & starflash®*



LDL B22/E27 range (registered design)



LDLH B22 SMD range



LDLFL-B22



F722-L / F732-L



In outdoor use, must be mounted on garland with B22 sockets minimum IPX4 with waterproof seal fitted.



flash

description	B22	E27	B22	B22	B22	
type of globe	polycarbonate	polycarbonate	polycarbonate	polycarbonate	polycarbonate	
ø of globe	45 mm	45 mm	45 mm	36 x 115 mm		
voltage	230V	230V	230V	230V	230V	
intensity	3,68VA	3,68VA	3,68VA		0,5J	2J
wattage	16mA max/0,5W	16 mA max/ 0,5W	16mA max/0,5W	3W	1W	1,3W
packing	set of 25	set of 25	set of 25	unit	unit	unit
pure white	<b>LDL11-B22</b>	<b>LDL11-E27</b>	<b>LDLH11</b>		<b>F722-L</b>	<b>F732-L</b>
warm white	<b>LDL11W-B22</b>	<b>LDL11W-E27</b>	<b>LDLH11W</b>			
amber	<b>LDL12-B22</b>	<b>LDL12-E27</b>	<b>LDLH12</b>	<b>LDLFL-B22</b>		
red	<b>LDL13-B22</b>	<b>LDL13-E27</b>	<b>LDLH13</b>			
blue	<b>LDL14-B22</b>	<b>LDL14-E27</b>	<b>LDLH14</b>			
green	<b>LDL16-B22</b>	<b>LDL16-E27</b>	<b>LDLH16</b>			
pink	<b>LDL18-B22</b>	-	<b>LDLH18</b>			

### product info

The LDL series is a classic of Blachere lighting. A registered model, the particular arrangement of the LEDs in the bulb globe gives a «filament effect» similar to the incandescent bulbs of yesteryear.

The polycarbonate globe guarantees an increased solidity (IK06).

The LDLFL-B22 recreates the effect of a flame, regardless of the mounting direction.

F722-L / F732-L  
A historical product that is easy to use on a B22 lampholder. Produces 1 flash approximately every 3 seconds.

Low power consumption bulb - Note : use the appropriate power (16mA i.e 3,68VA) to calculate the rating of your network (cable section area, circuit breaker, power required etc.). Use 0,5W per bulb to calculate the power consumption.



# Fil lumière®

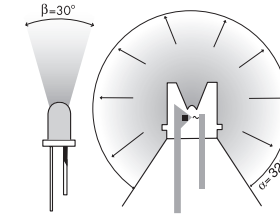

The use of inverted cone LED (see diagram) enables Blachère LED Garlands and Fil lumière products to offer exceptional luminosity. Can be divided every meter.

## PLATINIUM/ECO

30 Led/m



inverted 320° LED cone vertical position

## LED+

50 Led/m



Horizontal LED

## DUO COLORS®

30 Led/m



N



	Fil Lumière® eco	Fil Lumière® Platinum	Fil Lumière® Led+	Fil Lumière DUO COLORS®
density per led	30	30	50	30
P (W)/m	3,5	4	3,5	3,5
Roll	90,00m	50,00m	25,00m	25,00m
∅	1,20cm	1,20cm	1,30cm	1,30cm
IP	IP55	IP66-69	IP66	IP66
Couleur câble	■	■	■	□
○	NL5011	NLEDU51	NLED51+	
●	NL5011W	NLEDU51W	NLED51W+	
●	NL5012	NLEDU52	NLED52+	
●	NL5014	NLEDU54	NLED54+	
●	NL5016	NLEDU56	NLED56+	
●			NLED57+	
●			NLED58+	
●	NL5013	NLEDU53		
●				NLEDWW

### product info

Fil lumière® LED+ and Platinum : Ideal for highlighting facade.

Supplied with 3 special LED power supplies, 3 end caps, 3 connectors. Strictly for professional use.

Cannot be sold in shops.



## Pre-lit *swag garland*

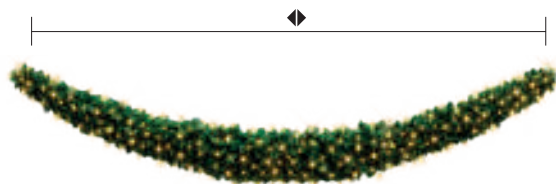

▶ swag garland per unit

◆	◀	LED	P (W)	🔌	■
3.00m	35cm	400 ●	30	6	GP303W
4.00m	35cm	500 ●	38	4	GP304W



## Fir garland stalactites *with flashes*

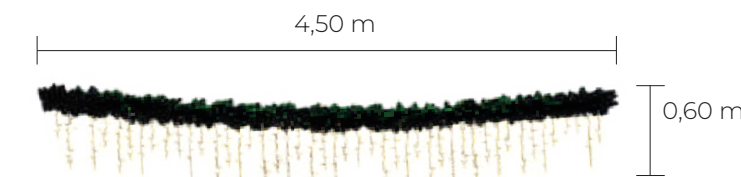

◆	◀	LED	F.	P (W)	🔌	🔌	◊	□
0.60m	4.50m	156 ○	48 ✪	13	48	15	○	GP138L
0.60m	4.50m	156 ●	48 ✪	13	48	15	●	GP139L-W





## Synthetic pre-lit fir garlands (set of 2)

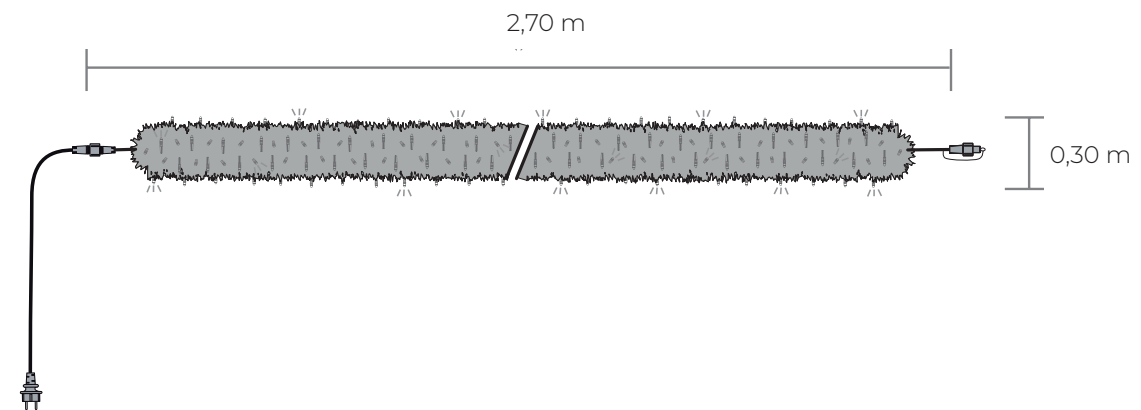

### ▶ with flash

◀	∅	LED	FLASH	P (W)	🔌	■
2,70m	0,30m	180 ●	60 ◉	11	10	GP134LWFX

### ▶ static

◀	∅	LED	P (W)	🔌	■
2,70m	0,30m	240 ●	11	10	GP134L-W

### product info

**Great classic for traditional street decorations.**

Quick-fit accessories, extension leads, multi-socket connectors Octoplus® 230V by Blachere®.

## Inflatable baubles ceiling lights



Using a conventional inflation gun

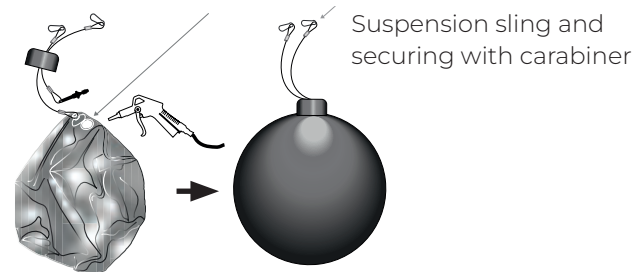

► Four-baubles set

∅	couleur	référence
50 cm	●	BG50-1
50 cm	●	BG50-3
50 cm	●	BG50-2
50 cm	●	BG50-4



## Gobo projector RGBW



dimen- sions	LED	⚡	☒	P (W)	Gobo size	reference
648 x 344 x 273 mm	RGBW	100-240V 50/60Hz	16kg	250W	66 mm	PRJPGOBO1
501 x 400 x 350 mm	Wall mount for PRJPGOBO1					PRM-GOBO1
501 x 252 x 400 mm	Pole mount for PRJPGOBO1					PRP-GOBO1





## Led rounded projectors for tree or pole



PRJA-W / PRJA

### ► Rounded projectors for trees (set of 2)

dim.	LED	tension	P (W)	ref
180 x 55 x 24 mm	2x6	24V	2 x 6W	<b>PRJA</b>
180 x 55 x 24 mm	2x6	24V	2x6W	<b>PRJA-W</b>
black switch-mode power supply 24V dc 25W (for a set of 2)				PRTR24N
elastic strap for PRJA-W and PRJA projectors				FYSDOW
protective and adhesive foam (set of 10)				FY-MOUS



## Led projector decorative



### ► Led decorative spotlight - unit - IP65 - class 1

LED	voltage	P (W)	reference
	230V	6	<b>PRJP-03W+</b>

## DMX controllable LED *projectors and wall washers*



PRJP3-DMX

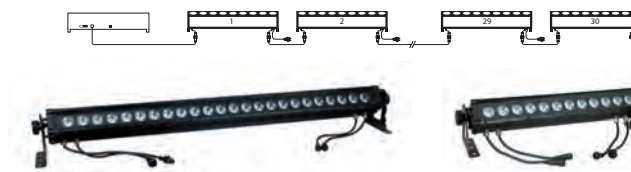

PRJR2-DMX



PRJR1-DMX

### ► DMX controllable LED projectors

dimensions	LED	spreading angle	⚡	☒	P (W)	reference
320 x 212 x 195 mm	18 RGB	45°	230V	5kg	70W	<b>PRJP3-DMX</b>

Tailor-made project, get closer to your account manager

### ► DMX controllable RGB wall washer

◆	LED	spreading angle	⚡	☒	P (W)	reference
58 cm	18 RGB	45°	230V	2,6kg	45W	<b>PRJR1-DMX</b>
110 cm	24 RGB	45°	230V	6,7kg	80W	<b>PRJR2-DMX</b>
6 m	DMX extension lead					<b>FY5P-DMX</b>
6 m	DMX signal extension lead					<b>FY5S-DMX</b>

### ► RGBW Projector

Dimensions	LED	Tension	Description	reference
21 cm x 12 cm x 15 cm	6 led x 5W RGBW	230V/50Hz	RGBW DMX	<b>HLPJRJPMX</b>

Option: controllable with infrared remote control (distance 3 to 4 m max). Simple functions.

#### product info

New range of RGB strip lights. Perfect for facades or monument illuminations.

Use of the SMD RGB led for a better lighting result.

Independent controller bringing greater autonomy thanks to the 10 pre-programmed animations or DMX interface box ref PR-DMX. For more information, please contact us.



# TECHNICAL SECTION



## CONTROL SYSTEM

*For optimised energy management*



**It's time to speed up the «Smart City» movement to save more energy.**

The challenge of eco-design and sustainable facilities, as well as smart energy management, are all part and parcel of a global eco-friendly urban policy. Blachere Illumination is committed to working alongside towns and cities and developing innovative solutions to protect our planet and our future.

With our lighting management systems, you can remotely manage lighting times and detect anomalies at the click of a button.

This will make it easier for cities to manage their electricity resources and keep them under control, in line with the city's aspirations for environmental protection and sustainable development.

Smart, energy-efficient systems for a sustainable city:

- ON/OFF switch (remote)
- timers
- energy-saving control systems:
  - autonomous
  - global system (SMART CITY)
  - event settings (Cameleon+)



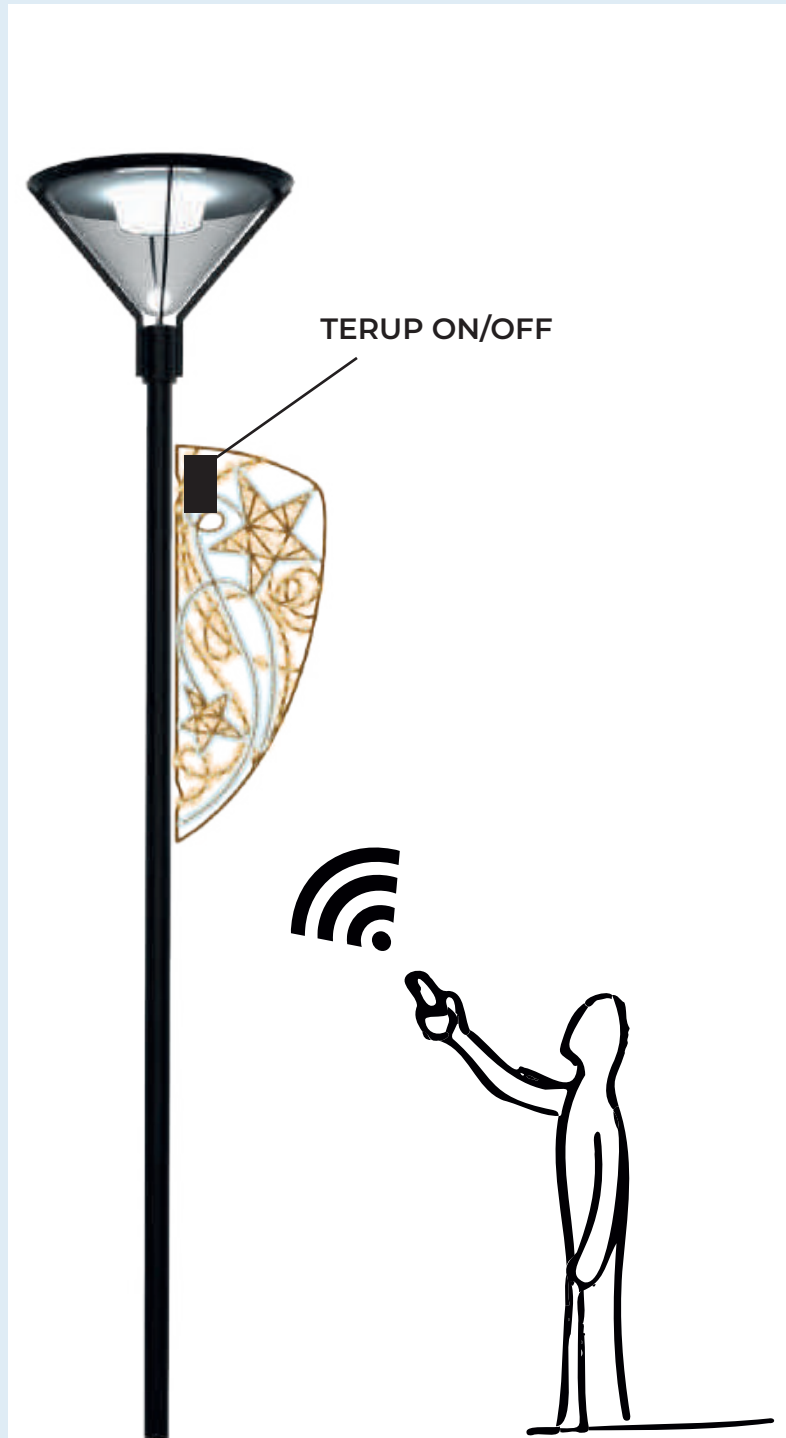

### ON/OFF LIGHT BOX WITH REMOTE CONTROL

With this remote control switch on your display, you can install and connect it to the street lighting in advance and switch it on manually with the remote control on the day the lights are switched on.

Compatible with TEMPO systems.

Ref : TERUP - ON/OFF box  
 Ref : TERUP-C - Remote control (can control several TERUPs)

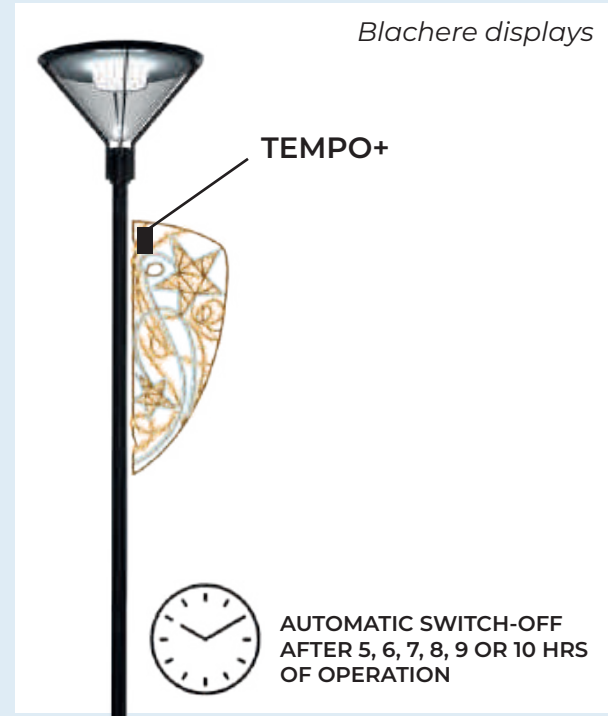

### «TEMPO+» BOX

Your display with the TEMPO+ box and disconnect it from the street light network - you can also set the lighting times you want.



At the touch of a button, select 5, 6, 7, 8, 9 or 10 hrs of operation then an automatic switch-off. Octoplus compatible.

Ref: TEMPO+



### «TEMPO2» BOX (UNIVERSAL)

Fit your display with the TEMPO2 box and disconnect it from the street light network. It is automatically programmed For 7 hrs of operation.



Compatible with Octoplus and/or any other displays.

Ref: TEMPO2

## “SAVER + MASTER» SYSTEM

- Creation of display sets
- Calendar programming (day & switch-on time)
- Optimised switch-on times.
- Secure communication network.

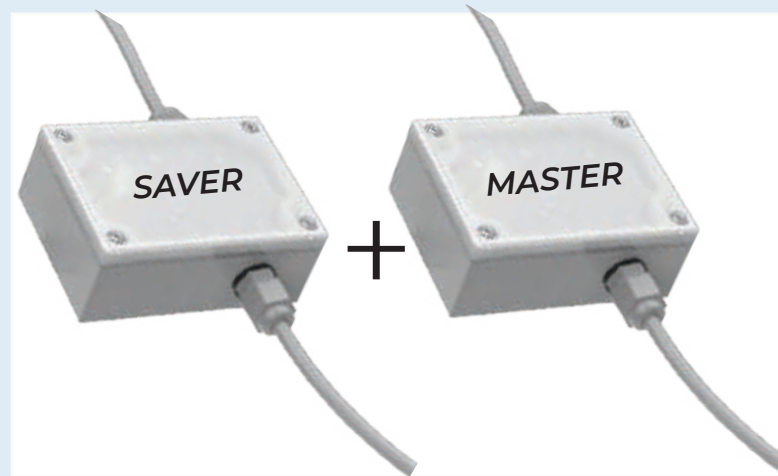

Fit your light displays with “SAVER” boxes. One of the displays will be the «group leader» and will have a “MASTER” box. Distance between a SAVER and MASTER: max. 50m.

The MASTER box can be programmed with the switch-on times/days and will transmit the same information to all the SAVERS.

Pre-programmed system or that can be programmed by the customer via the dedicated mobile app.

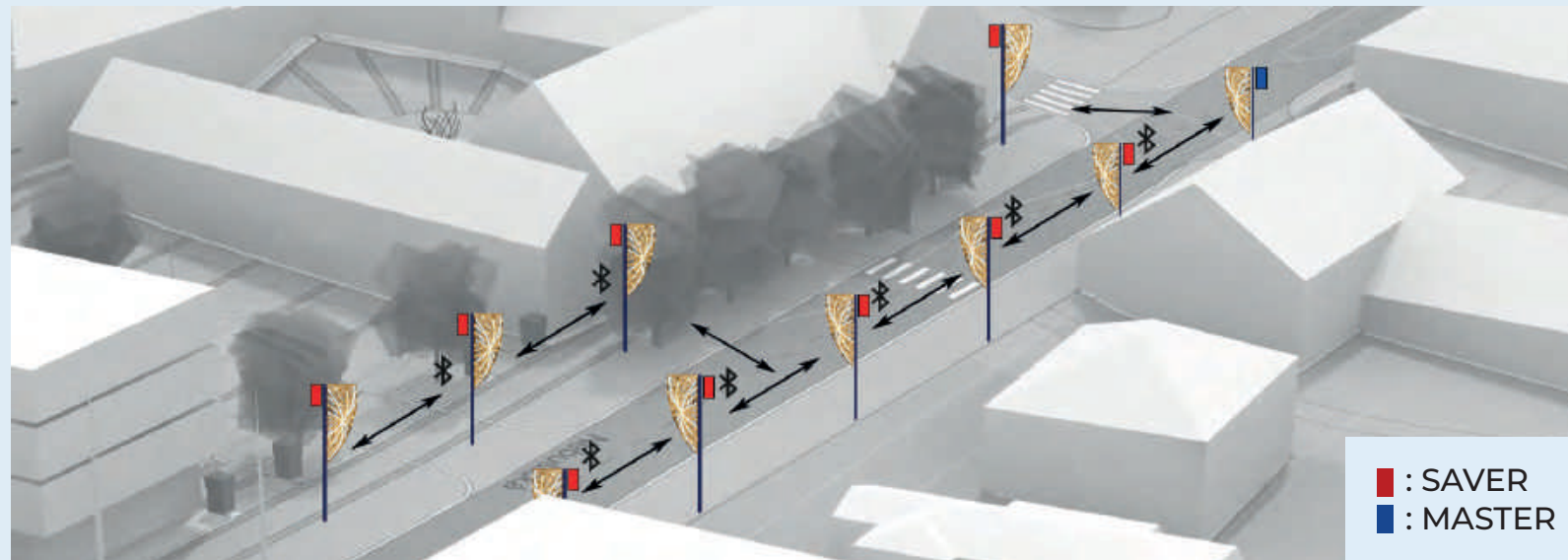

## “SAVER + SUPER MASTER» SYSTEM

- Track energy savings
- Creation of display sets
- Calendar programming (Days & times when sets are switched on)
- Remote management of lights
- Remote control management
- Alert management (anomalies)
- Real-time view of displays
- Optimised switch-on times
- Secure communication network
- Customisable interface
- Lighting scenarios (staggered lighting, etc.)

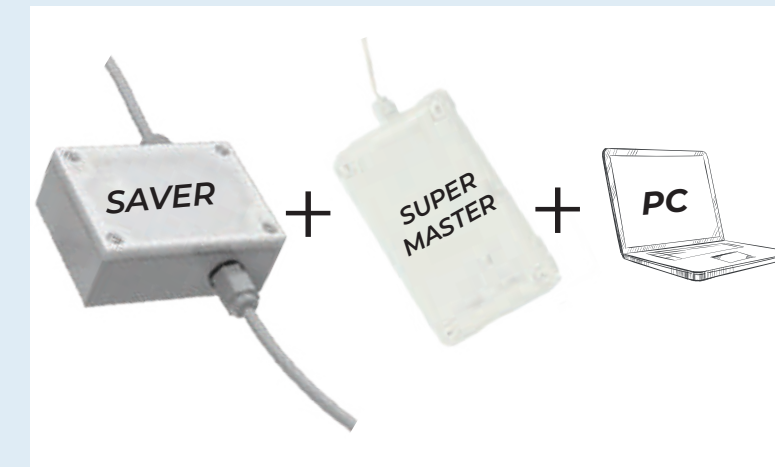

Equip all your displays with «SAVER» boxes. One of the displays has a «SUPER MASTER» box.

This controls all the «SAVER» boxes and transmits the same information to them (time/day of switching on/off).

At the same time, the «SUPER MASTER” sends information to the central system (PC + web interface) via GSM network (SIM card).

Manage all the settings for your town/city on your PC.

System requires a custom study

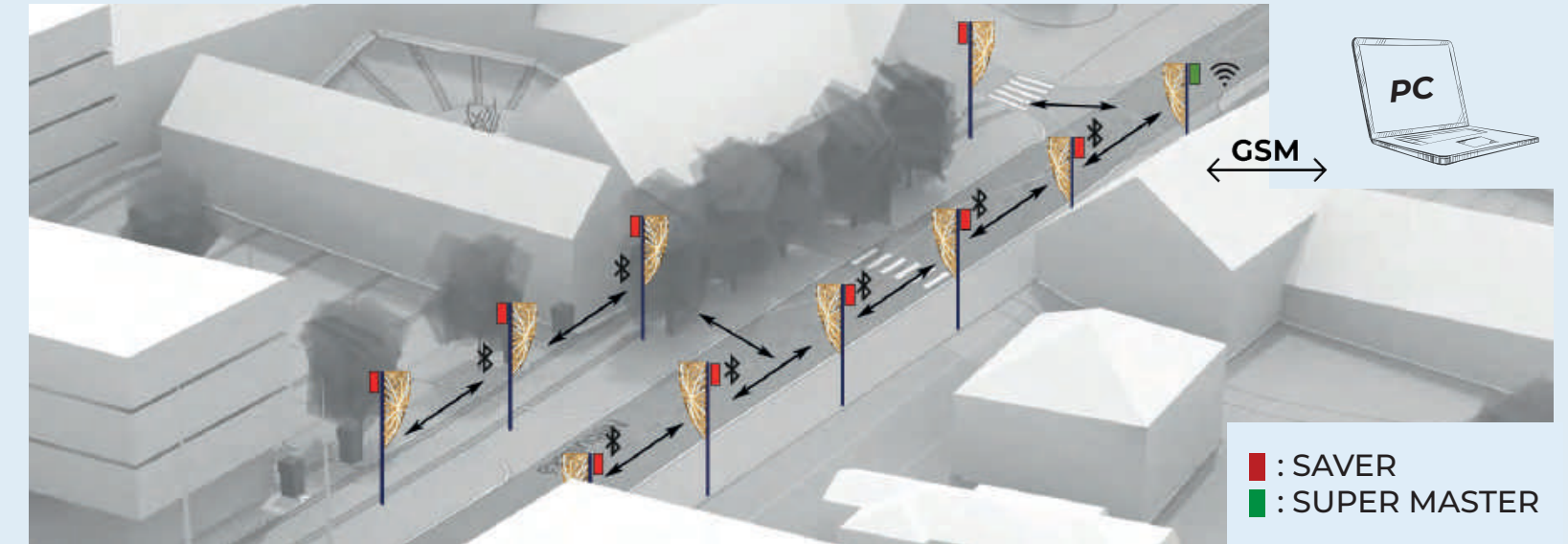

# OCTOPLUS BY BLACHERE®

**Exclusive**



Octoplus by Blachere® 230V connector, protection rating **IP67**, according the European standard EN60529 on the degree of protection provided by enclosures.



Safety extra-low voltage connector 12/24V

**Octoplus** is the connector that enables **fast and multiple connection** between our decorations and most of our range of garlands. Each item that is marked "Octoplus" can therefore **be connected** to another "Octoplus" item. This means **the combination of items is infinite** just by simplifying the electrical connections.

## Octoplus®: Example of use No.1



For a transverse motif

	QTÉ	PAGE
FY08-B+	1	240
FY043A-B+	1	240
FY01-3B+	1	240
FL390WBF+	1	187
FCL080G-E	2	199
FYPRT9B	2	242
FYT-B+	2	240

To install on steel wire with PVC sheath

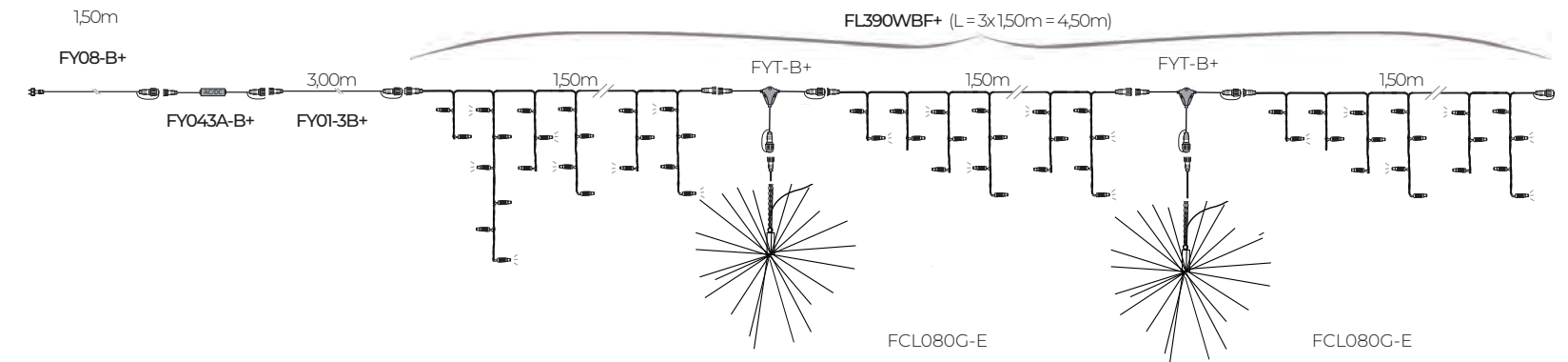



For a width of 4.50m

FY08-B+	1	240
FY043A-B+	1	240
FY01-2B+	1	240
354W	1	189
FYT-B+	2	240
FYPRTR9	2	242
G-FL900	2	204

To install on steel wire with PVC sheath

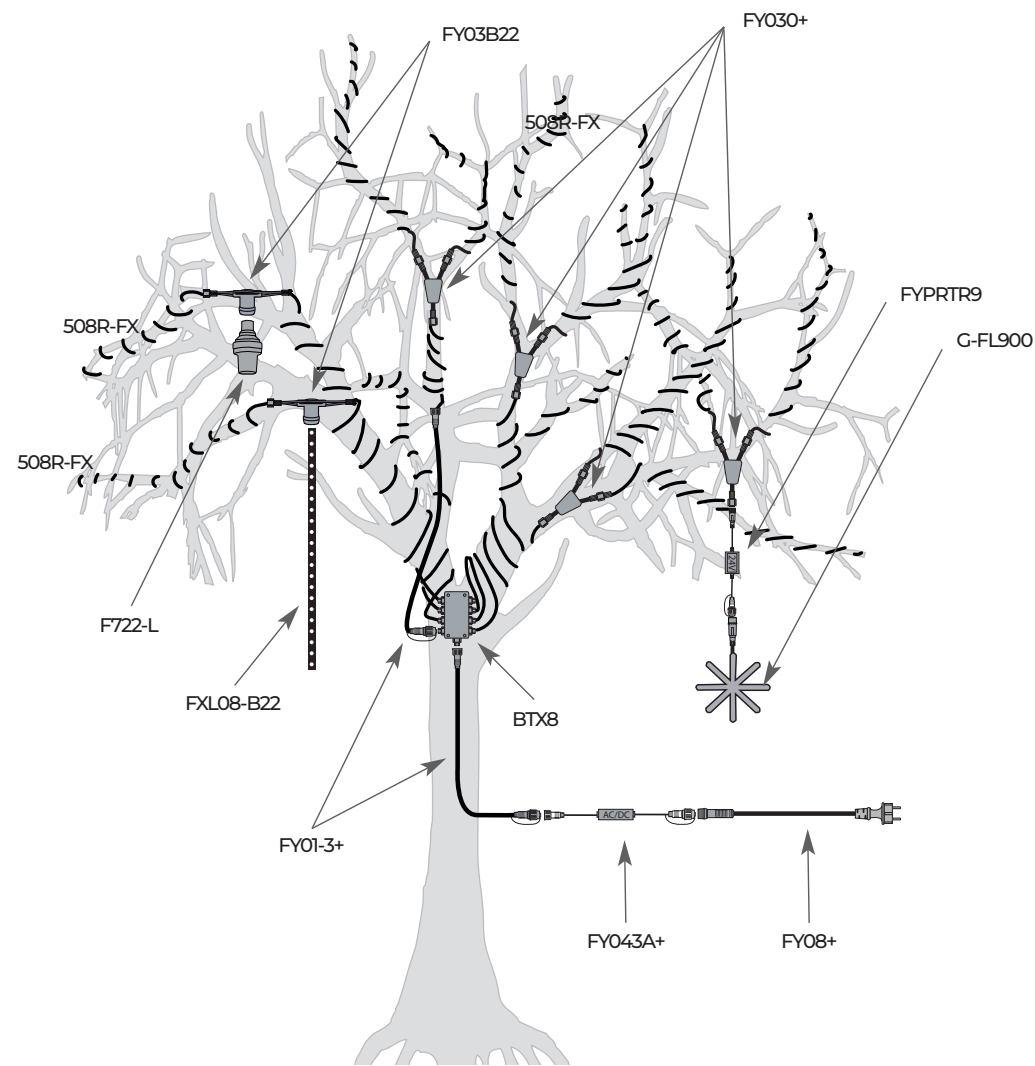
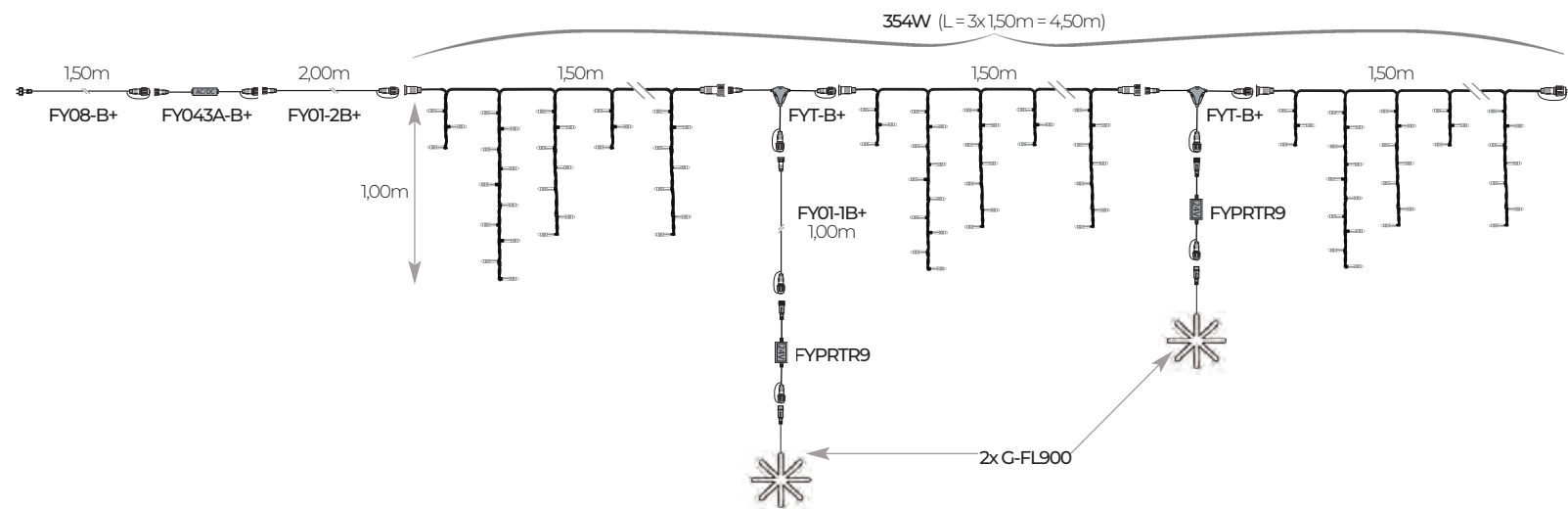

Réf.	Quantity	Page
FY08-B+	1	240
FY043A-B+	1	240
FY01-3+	2	240
BTX8	1	240
508R-FX	10	163
FY030+	4	240
FYPRTR9	1	234
G-FL900	1	204
FY03B22	1	241
FYL08-B22	1	210
F722-L	1	227

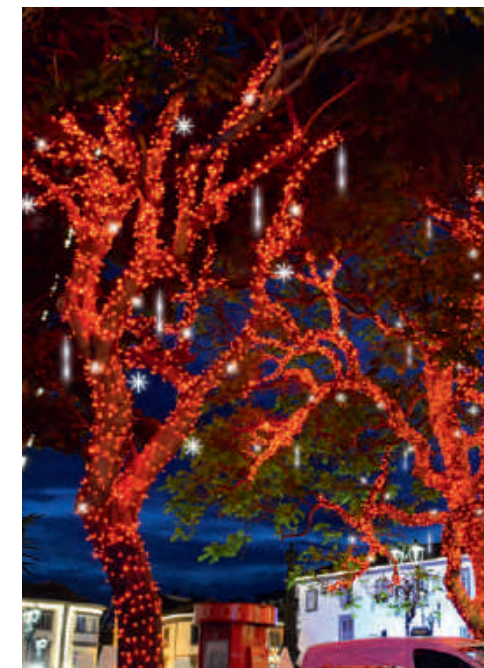



Diagram/Picture	Description		■	□
	Power cable 230V - 1.5m - HO5RN-F - 2x1mm <sup>2</sup> with male plug and female Octoplug connector	Euro	FY08+	FY08-B+
		UK	FY08-UK+	FY08-BUK+
		Swiss	FY08-S+	FY08-BS+
		Wieland	FY08-W	FY08-BW
	AC/DC bridge rectifier (compulsory) for LED+ with Octoplug connector (M+F)	1A/230W	FY041A+	FY041A-B+
		3A/690W	FY043A+	FY043A-B+
	Octoplug extension 230V - HO5RN-F - 2x1mm <sup>2</sup>	1m	FY01-1+	FY01-1B+
		2m	FY01-2+	FY01-2B+
		3m	FY01-3+	FY01-3B+
		5m	FY01-5+	FY01-5B+
		10m (2X5m)	FY01-10+	FY01-10B+
	Set of 5 end-caps plugs		FY1C+	FY1CB+
	T connector 230V		FYT+	FYT-B+
	Y connector 230V		FY030+	FY030-B+
	W connector 230V		FY031+	FY031-B+
	Collector - 230V - HO5RN-F L = 2 x 1.60m = 3.20m 20cm between connectors with 16 sockets and steel wire with PVC-coating 690 W max in total		FY023+	FY023-B+

Diagram/Picture	Description	Obs.	■	□
	IP66 multi-socket box with 4 Octoplug (F) outputs and one Octoplug (M) input	690 W max	BTX4	BTX4-B
	IP66 multi-socket box with 8 Octoplug (F) outputs and one Octoplug (M) input	690 W max	BTX8	BTX8-B
	230V adaptor Sparklight and Stalactites (connector 2017 -> connector 2018)	-	FY230F2	FY230F2-B
	230V adaptor Sparklight and Stalactites (connector 2018 -> connector 2017)	-	FY230M1	FY230M1-B
	B22 bushing with M/F Octoplug connector	5W max	FY03B22	FY03B22-B
	Elasticated "SPECIAL TREE" connector to let the tree grow without any restrictions	set of 5	FY07A	.
	20cl tube of silicone sealant for full sealing of connectors (extreme environment)	-	NLC60	-
	IP66 quick connector for HO5RN-F cable	-	BT04	-
	Protective and adhesive foam	set of 10	FY-MOUS	-





Schéma/Photo	Descriptif	Obs.	■	□
	1m extension PVC cord 24V Connectors M-C1/F-C2		FY01-PVC	FY01B-PVC
	2m extension PVC cord 24V Connectors M-C1/F-C2		FY02-PVC	FY02B-PVC
	5m extension PVC cord 24V Connectors M-C1/F-C2		FY05-PVC	FY05B-PVC
	2 output connector PVC 24V Connectors M-C1/F-C2		FY2-PVC	FY2B-PVC
	3 output connector PVC 24V Connectors M-C1/F-C2		FY3-PVC	FY3B-PVC
	230V -> 24V transformer with Octopus connector	10W max	FYPRT9	FYPRT9B
	Transformer 230V / 24V with Octopus connectors	100W		PRTR100W
	collector 24V - PVC L: 80cm - 4 sockets - spacing 20cm		FY024	FY024-B

Electrical accessories for LED Platinum fil lumière®



**NLC95-12** fil lumière® Led power cord kit  
The kit includes: 1 rubber power lead of 1m with plug and polarized connector + integrated AC/DC bridge rectifier, 1 power lead spin, 1 full spin, 1 pot of glue and 1 end cap.

**NLC51L-12** Glueable L connector

**NLC92-12** Standardized glueable central "spins"

**NLC54-12** Glueable insulation end cap

Fixing accessories for Led fil lumière®



Repair kit for Led Platinum fil lumière® - 230V - IP55 - ø 12mm

For Blachere Illumination motifs only

<b>NLKL01-12</b>	10 m of fil lumière®	white Led	○ (type NML41),	2 power leads	glue	10 connectors,	5 end caps
<b>NLKL02-12</b>	10 m of fil lumière®	blue Led	● (type NML42),	2 power leads	glue	10 connectors,	5 end caps
<b>NLKL06-12</b>	10 m of fil lumière®	red Led	● (type NML46),	2 power leads	glue	10 connectors,	5 end caps
<b>NLKL01W12</b>	10 m of fil lumière®	warm white Led	○ (type NML41W),	2 power leads	glue	10 connectors,	5 end caps



Photo	Infos	Ref
	Heart shape eye for ø 4mm cable set of 10	<b>D001</b>
	Heart shape eye for ø 6mm cable set of 10	<b>D011</b>
	Cable gripper for ø 4mm cable set of 10	<b>D002</b>
	Cable gripper for ø 6mm cable set of 10	<b>D012</b>
	Steel cable ø 4mm 100m roll	<b>D005</b>
	Steel cable ø 6mm 100m roll	<b>D006</b>
	Steel cable ø 4mm with PVC sheath ø 6mm 100m roll	<b>D015</b>
	Steel cable ø 6mm with PVC sheath ø 8mm 100m roll	<b>D016</b>

Photo	Infos	Réf
	Transverse unit for fas- tening to pole for ø 11mm cable pair	<b>MA011</b>
	Eyebolt L : 150mm set of 2pcs	<b>D033</b>
	Galvanized steel shackle ø 10mm	<b>MA002</b>
	Mixed stretcher unit - M10 L : 22 to 30cm	<b>D004</b>
	ø 6mm Snap hook WLL 80kg	<b>D0M7T</b>
	safety sling L : 60cm WLL : 70kg	<b>D026</b>



Ref: C001  
differential circuit-breaker  
equipped with a waterproof  
power plug.  
(for poles)  
Note : box subject to modification  
according to availability



230V - IP55 protection housing  
with insulated transformer (for a large  
quantity of Spark Light /Octoplus)  
with 8 AC/DC Octoplus rectified  
outputs. (Ideal to reduce leakage  
current).

Note : box subject to modification  
according to availability

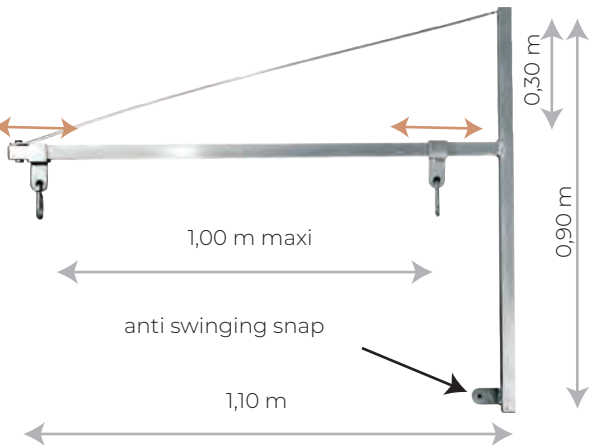
Ref: PIX01  
Horizontal bracket  
H:0,90 m - L: 1,10 m  
inter distance max: 1,00 m -max load: 25 kg



Inverted cone  
1 PIX03 (up)  
1 PIX04 (down)  
2 curtains H : 5m

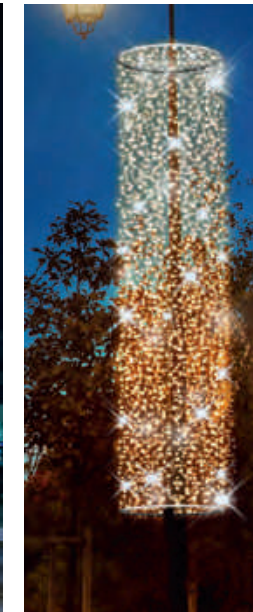

Cylinder  
2 PIX03  
2 curtains H : 5m

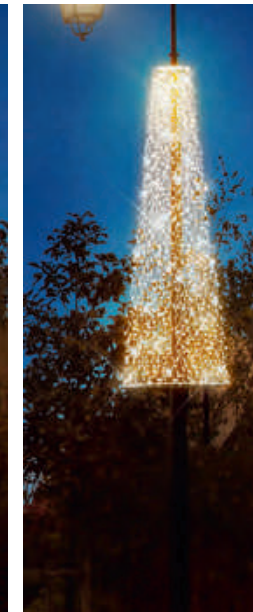

Christmas tree  
1 PIX04 (up)  
1 PIX02 (down)  
1 curtain H : 3m

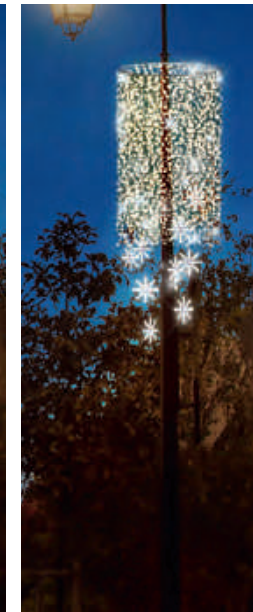

Free composition  
2 PIX03  
1 FL74WBF+  
1 FL900E

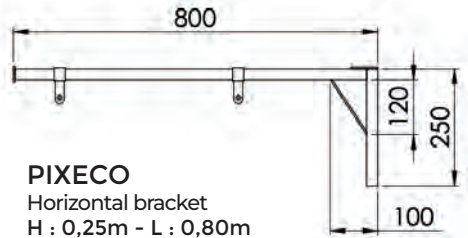
**PIXECO**  
Horizontal bracket  
H : 0,25m - L : 0,80m  
max load : 10kg

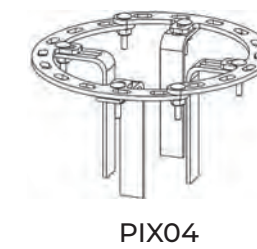
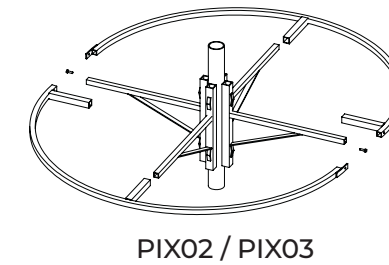

Circular brackets  
Put together low-price 3D decorations  
on your columns with our circular brackets  
(inner diameter adjustable)

Ref	∅	Perimeter	pole ∅	usable with
PIX04	25 cm	0,80 m	60 à 120 mm	Curtains
PIX02	60 cm	1,90 m	60 à 200 mm	
PIX03	130 cm	4,00 m	60 à 200 mm	

“Order your FIX01 fixing to colour match your lamp columns!!!  
Let us know the corresponding RAL and get a customized quotation. Contact our sales department for information”

**FIX01 (pair)**  
Fastening device for pole



**FIX01P (pair)**  
Strengthened fastening devices for poles (storm conditions) (wind area 3)

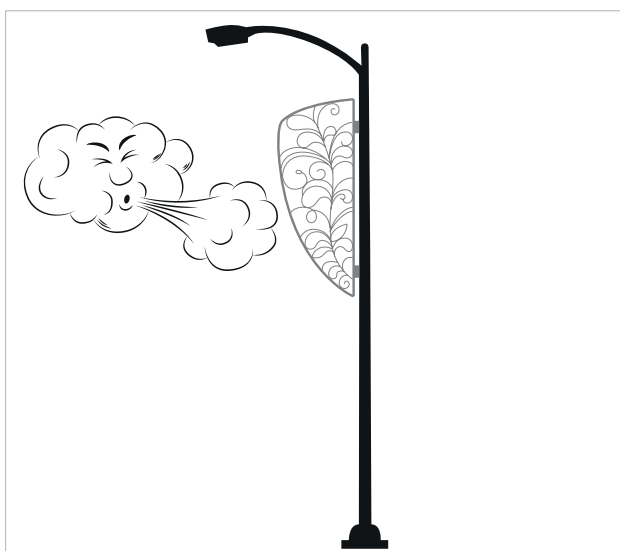
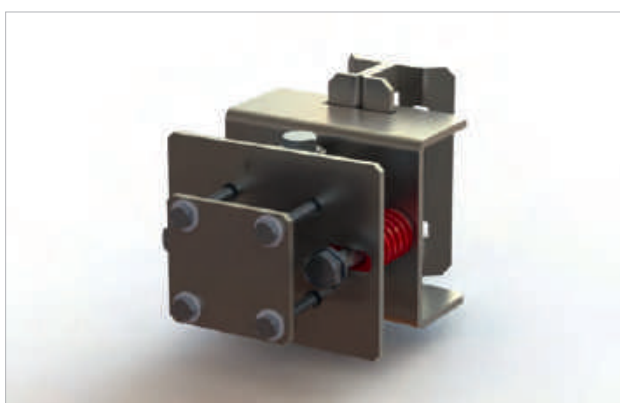

“Order your FIX01 fixing to colour match your lamp columns!!!  
Let us know the corresponding RAL and get a customised quotation. Contact our sales department for information”

**FIX01M (pair)**  
Fastening devices for facades

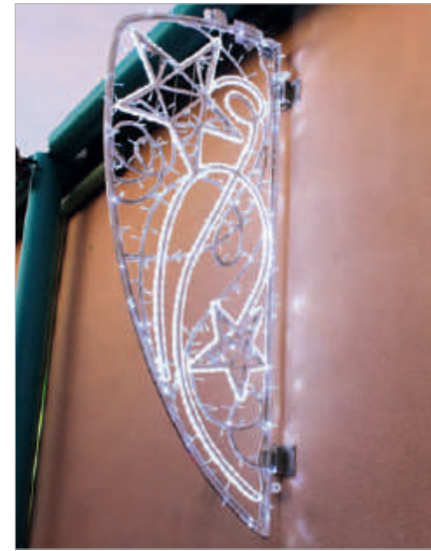

**FIX01MC (pair)**  
Fastening devices for curved pole

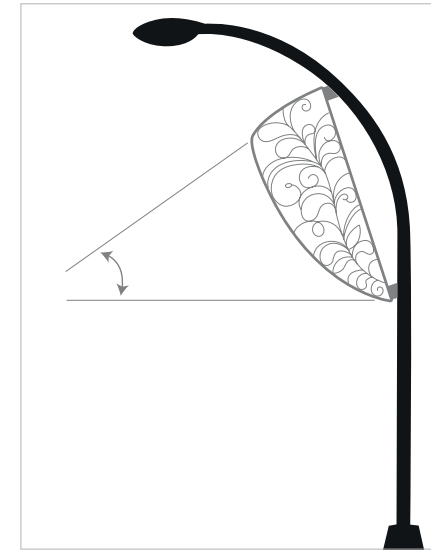
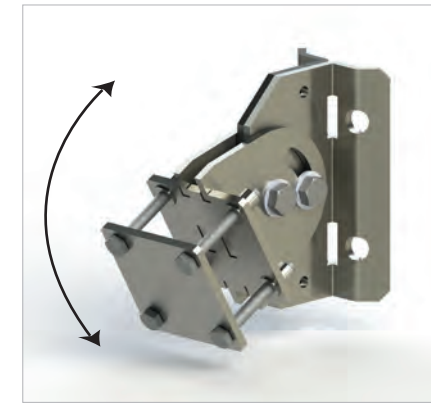

Each fastening must be individually strapped twice (see diagram). For motifs exceeding a height of 3.5m, it is essential to use three fasteners per motif.  
Ref: D007  
Stapping box including 1 cutting pliers and 1 stapping pliers.  
Ref: D008  
Stainless steel strap Roll of 50m thickness : 0,7mm  
Ref: D009  
Staple-clip for steel strapset of 100  
Ref: D010  
Black protection strip for Stainless steel strap - L: 10 ml / 10 mm



D008



D007

D010

D009



**FYS060N**  
Fixing of decorations on masts.  
Black strap: l: 15mm, L: 600mm, 8cm mini ratchet, LC 50 daN  
This strap is reusable and does not slip

Picture	Infos	Réf
	To complement your decorations, we can provide you with our real fir trees sustainably cultivated and processed with flake finish based on fireproof natural cellulose fibre. Contact our sales department and choose your colours and finish.	
	Pyramid ballast 25kg Base 38 cm x 38 cm with carry handle	<b>PLOSAC25</b>
	Mounting base for 3D motif ø : 800mm	<b>PLA800OR</b>
	Mounting base for 3D motif ø : 1200mm	<b>PLA1200OR</b>

Picture	Infos	Réf
	Technical data : - Full kit with solar panel, 12V gel batteries, power regulator and protection against discharges. - Gel batteries for 2400 cycles with 30% discharge. - Prevent battery damages with low power protection . - 24V or 230V output to indicate with your order. - Can be fixed on floor.	
	+ : - 50% of battery consumption after 12 hours. - Easy to move with flexible rubber wheels with high degree of resistance to abrasion. - No maintenance and easy installation. <b>KITSOL</b>	
	20W panel power 7.2W power output DAILY PROGRAMMER: selecting the days and times when the decor is switched on. 8 to 10 hours of sunshine required for 7 hours of operation <b>PIXSOL2</b>	
	12W panel power 4W power output DAILY PROGRAMMER: selecting the days and times when the projector is switched on 8 to 10 hours of sunshine is required <b>PIXSOL3</b>	

Picture	Infos	Réf
	Square Carpet Blue 4m x 4m	<b>GPC300B</b>
	Round carpet Blue ø : 3m	<b>GPR300B</b>
	Square Carpet Red Square Carpet Blue 4m x 4m	<b>GPC300R</b>
	Round carpet Red ø : 3m	<b>GPR300R</b>

Picture	Infos	Réf
	White cotton carpet roll 30m x 2,6m	<b>GP500</b>
	Red carpet roll 10m x 2m	<b>GP510R</b>
	Red - ø 140mm Lot de 16	<b>B14-1</b>
	Gold - ø 140mm Set of 16	<b>B14-2</b>
	Red - ø 200mm Set of 9	<b>B20-1</b>
	Gold - ø 200mm Set of 9	<b>B20-2</b>
	Red - ø 250mm Set of 9	<b>B28-1</b>
	Gold - ø 250mm Set of 2	<b>B28-2</b>
	barrier Opéra H : 1,20m L : 2,00m	<b>BARR01</b>
	White pine barrier H : 0,80m L : 1,80m	<b>GP506-B</b>

# 262 BALLASTING ILLUMINATIONS

Dress up your blocks as pretty gifts



GX165L - Santa Rock : 460 kg

- GX165L +
- . 3 x KPLO100B + KGIVO3 + KGIRO3 + KGIBA3
- . 3 x KPLO040 + 2 X KGIVO2 + KGIRO2
- . 2 x KPLO020 = KGIRO1+ KGIBA1

Use our magical gifts to hide the concrete blocks in your decorations!

Depending on the features of your decoration, put together your own ballast kit and wrap your gift (size & colour).

**Technical details:**

**1. Choose your block**

Reference	description	dimensions
KPLO100B	Concrete block - 100kg	0,37 x 0,37 x 0,37m
KPLO040	Concrete block - 40kg	0,30 x 0,30 x 0,20m
KPLO020	Concrete block - 20kg	0,20 x 0,20 x 0,20m

**2. Choose your cover**

reference	description	dimensions	colour
KGIBA1	Block cover - PM	0,2 x 0,2 x 0,2m	blue / silver
KGIBA2	Block cover - MM	0,3 x 0,3 x 0,2m	blue / silver
KGIBA3	Block cover - GM	0,37 x 0,37 x 0,37m	blue / silver
KGIRO1	Block cover - PM	0,2 x 0,2 x 0,2m	red / gold
KGIRO2	Block cover - MM	0,3 x 0,3 x 0,2m	red / gold
KGIRO3	Block cover - GM	0,37 x 0,37 x 0,37m	red / gold
KGIVO1	Block cover - PM	0,2 x 0,2 x 0,2m	green / gold
KGIVO2	Block cover - MM	0,3 x 0,3 x 0,2m	green / gold
KGIVO3	Block cover - GM	0,37 x 0,37 x 0,37m	green / gold

Wrapping steps (13 clips are supplied)



KPLO100B + KGIRO3

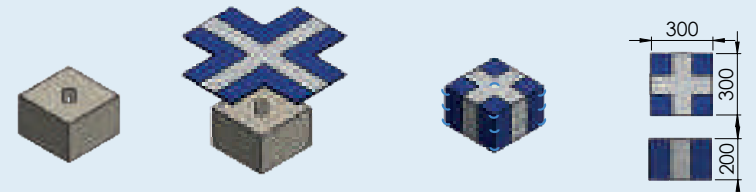

KPLO040 + KGIBA2



KPLO020 + KGIVO1

Enter the reference for the decoration + the block + the cover

# INDEX



AR001	104
AR002	104
ARCOM	104
ARTOT02	104
CIME2	113
CIME4	113
CIME6	113
CIME7	113
GP157W	119
GSV140	119
GSV140B	119
GX042L	86
GX047L	83
GX048LW	76
GX070CL	131
GX070LR	133
GX079L	83
GX081LW-2	110
GX082LW	110
GX083LW	110
GX086L	99
GX086L-A	99
GX087L	92
GX088L	98
GX092L	88
GX093L	88
GX097L	98
GX098L	98
GX102L	102
GX102LW	95
GX103L	105
GX103L-A	105
GX105L	90
GX107	144
GX107-UK	144
GX108	144
GX108-UK	144
GX109	144
GX109-UK	144

GX110	110
GX110-UK	110
GX112L	102
GX112L-UK	102
GX114LW	75
GX115LW	92
GX116LW	76
GX117LW	76
GX118DC	89
GX118L	103
GX119L	103
GX132L	93
GX133L	99
GX145L	82
GX145L-A	82
GX146L	105
GX147L	84
GX148L	93
GX149L	81
GX151L	90
GX152L	90
GX153L	97
GX154LW	133
GX155LW	132
GX156LW	135
GX159L	86
GX160L	83
GX163L	84
GX164L	85
GX165L	91
GX165L-A	91
GX166L	91
GX166L-A	91
GX167L	91
GX167L-A	91
GX168LW	135
GX171RGBW	130
GX172LW	100
GX173L	126

GX173LW	126
GX182L	96
GX182L-A	96
GX184L	138
GX184LW	138
GX185LW	128
GX193L	95
GX194L	89
GX195L	103
GX200L	81
GX204L	102
GX205L	85
GX206L	85
GX210LW	135
GX242L	149
GX244L	95
GX245LW	87
GX247L-A	95
GX248LR	97
GX249L	85
GX249L-A	85
GX250L-A	82
GX251L	122
GX251LW	122
GX252L	134
GX252LW	134
GX253LW	123
GX256LW	100
GX257LW	100
GX258L	101
GX258LW	101
GX259LW	101
GX260L	102
GX260LW	102
GX261LW	92
GX262LW	87
GX263L	94
GX264LW	94
GX265LW	86

GX266BC	127
GX267LW	95
GX308L	98
GX327L	137
GX327LW	136
IPL028B	51
IPL031W	35
IPL035	51
IPL039	63
IPL039W	63
IPL042W	114
IPL043R	65
IPL043W	65
IPL069	55
IPL070B	65
IPL070R	65
IPL070W	65
IPL072W	55
IPL075B	55
IPL075W	55
IPL076	54
IPL076W	54
IPL081W	35
IPL082W	35
IPL084	55
IPL087W	35
IPL094W	61
IPL101W	29
IPL108W	38
IPL110	39
IPL110W	39
IPL114W	77
IPL115W	35
IPL117W	55
IPL118W	55
IPL120	42
IPL120B	42
IPL120R	42
IPL120W	42

IPL122	49
IPL124	51
IPL126	55
IPL126W	55
IPL127	39
IPL127W	39
IPL128	39
IPL128W	39
IPL129	27
IPL129W	27
IPL130	27
IPL130W	27
IPL131	27
IPL131W	27
IPL132	39
IPL133	39
IPL134W	77
IPL135	35
IPL135W	35
IPL139W	77
IPL140W	77
IPL141W	63
IPL142R	65
IPL143	25
IPL143W	25
IPL144	25
IPL144W	25
IPL145W	63
IPL146B	41
IPL146R	41
IPL146W	41
IPL147B	41
IPL147W	41
IPL148B	41
IPL148R	41
IPL148W	41
IPL149B	49
IPL150	49
IPL151W	63

IPL158W	29
IPL160	49
IPL189B	59
IPL189R	59
IPL189W	59
IPL190B	59
IPL190R	59
IPL190W	59
IPL191B	61
IPL191R	61
IPL191W	61
IPL199	23
IPL199W	23
IPL200	23
IPL200W	23
IPL201	23
IPL201W	23
IPL202W	29
IPL203W	29
IPL226W	29
IPL228B	59
IPL228W	59
IPL230	25
IPL230W	25
IPL231W	29
IPL257	47
IPL257B	47
IPL257W	47
IPL258	47
IPL258B	47
IPL258W	47
IPL259	47
IPL259W	47
IPL260W	47
IPL265W	75
IPL266W	75
IPL267W	75
IPL268W	75
IPL270R	73

IPL270W	73
IPL271R	73
IPL271W	73
IPL272	22
IPL272W	22
IPL282BC	33
IPL283BC	33
IPL284BC	33
IPL285BC	33
IPL286BC	33
IPS264W	78
IPS280	78
IPS280W	78
IPS281W	78
IPS289W	78
IPS290	78
ITGL100	36
ITGL101W	36
ITGL102	66
ITGL102W	66
ITGL104	66
ITGL104W	66
ITGL105	66
ITGL105W	66
ITGL111	67
ITGL111W	67
ITGL112	67
ITGL112W	67
ITGL117R	68
ITGL130W	68
ITGL131	66
ITGL131W	66
ITGL141	68
ITL009	28
ITL020B	53
ITL020W	53
ITL021	52
ITL022	53
ITL022W	53

ITL025W	61
ITL027W	63
ITL028B	50
ITL033W	34
ITL035	50
ITL043W	38
ITL051	69
ITL051B	69
ITL051R	69
ITL051W	69
ITL052	69
ITL052B	69
ITL052R	69
ITL052W	69
ITL053	69
ITL053B	69
ITL053R	69
ITL053W	69
ITL059W	54
ITL061	28
ITL072W	54
ITL076W	54
ITL077W	34
ITL082W	61
ITL083W	61
ITL084W	73
ITL094W	60
ITL101	52
ITL101W	52
ITL102	52
ITL102W	52
ITL105	50
ITL109W	61
ITL113W	74
ITL115	53
ITL115W	53
ITL118W	54
ITL120	42
ITL120B	42

ITL120R	42
ITL120W	42
ITL126	48
ITL127	38
ITL127W	38
ITL129	139
ITL129W	139
ITL130	26
ITL130W	24
ITL132W	38
ITL135	34
ITL135W	34
ITL160	48
ITL161	24
ITL161W	24
ITL162W	60
ITL163	48
ITL165W	74
ITL166B	40
ITL166R	40
ITL166W	40
ITL167	48
ITL191B	60
ITL191W	60
ITL218W	29
ITL226W	28
ITL227B	58
ITL227W	58
ITL232W	28
ITL233	26
ITL234W	58
ITL261	46
ITL261B	46
ITL261W	46
ITL262	46
ITL262B	46
ITL262W	46
ITL266W	74
ITL275R	72

ITL276R	72
ITL276W	73
ITL277W	73
ITL278W	72
ITL279R	73
ITL279W	72
ITL282BC	32
ITL288BC	32
ITL291	24
ITL291W	24
KIT1-134	148
KIT2-242	149
KIT2-134	148
KIT2-242	149
KITNDK-A	112
KITNDK-B	112
KITNDK-E	112
KITNDK-F	112
KITNDK-O	112
KITNDK-R	112
PIXSOL2	79
PL250	43
PL250B	43
PL250W	43
PL344	43
PL344W	43
SC014	107
SC015	107
SC016	107
SC017	107
SC018	107
SC019	107
SC020	107
SC021	107
SC022	107
SC023	107
SC024	107
SC025	107
SL005	125

SL005W	125
SL012	136
SL012W	136
SL013	136
SL013W	136
SL019CL	131
SL032	137
SL032W	137
SL033	137
SL033W	137
SL035W	132
SL036	136
SL036W	136
SL037W	136
SL038B	97
SL038R	97
SL038W	97
SL039W	124
SL040	141
SL041W	120
SL043W	120
SL044W	140
SL045V	120
SL046W	115
SL047	128
SL048	116
SL049W	116
SL050R	135
SL134	148
SL135W	139
SL136	139
SL136W	139
SLED010W	115
SND017	121
SND018	121
SND019	121
SND021	117
SND022	120
SOCL42	81



SOCL43	88
SOCL47	87
SOCLGX81	113
SOCLGX82	113
SOCLGX83	113
SV1001	118
SV1001W	118
SV1201-P	118
SV1201W-P	118
SV1401	118
SV1401W	118
SV301	118
SV301W	118
SV302	114
SV302W	115
SV303	114
SV303W	115
SV501	118
SV501W	118
SV502	114
SV502W	115
SV504A	93
SV504B	93
SV504C	93
SV505CL	129
SV506RGBW	129
SV801-P	118
SV801W-P	118
TGL139W	53
TGL157	36
TGL157W	37
TGL158LW	77
TGL169LW	75
TGL247LW	76
TGL70LW	69
TGL70LWW	69
TGL71LW	69
TGL71LWCL	69
TGL71LWW	69

TGL72LW	69
TGL72LWW	69
TL311R	62
TL311W	65
TL312R	62
TL312W	65
TL347W	29
VL045W	55
VL046	27

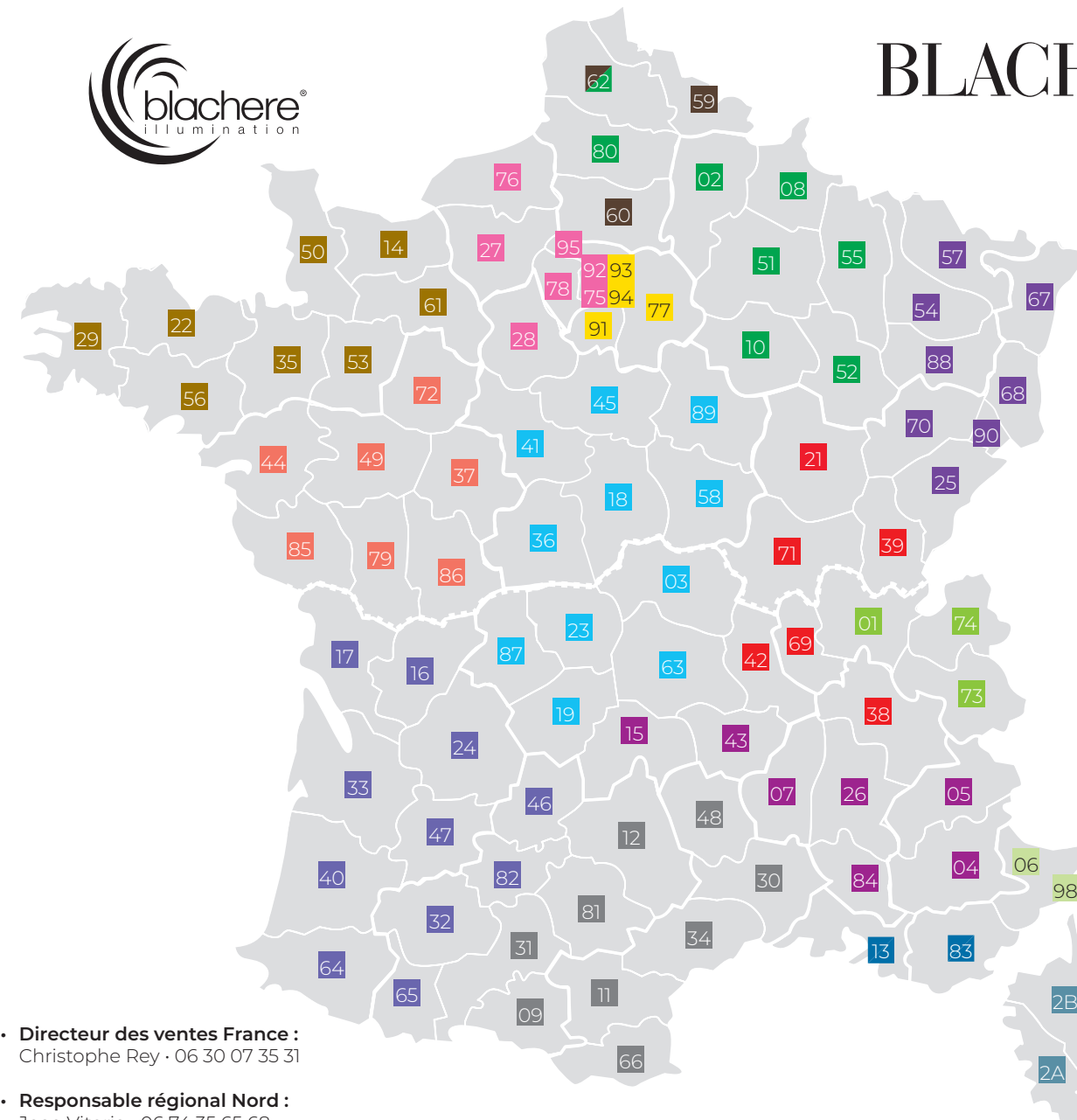

• **Directeur des ventes France :**  
Christophe Rey · 06 30 07 35 31

• **Responsable régional Nord :**  
Joao Vitoria · 06 74 35 65 68

• **Responsable régional Centre :**  
Sébastien Bouvet · 06 08 80 47 66

• **Responsable régionale Sud :**  
Aude Grojsman · 06 74 48 50 41

• **Chef de projet Studio Blachere Illumination - Paris :**  
Cédric Parcineau · 01 42 77 66 15  
· 07 77 26 37 76

• **Directrice administration des ventes :**  
Géraldine Esposito · 04 90 74 73 23

• **Responsable distributeurs nationaux :**  
Françoise Grégoire · 04 90 74 73 20  
· 07 84 11 22 41  
Nathalie Soustelle · 04 90 74 73 34

# BLACHERE *FRANCE*

## Île-de-France Est

Sophie Duquesnoy · 06 08 00 57 52  
Assistante, Sarah Galizzi · 04 90 74 73 61

## Île-de-France Ouest

Véronique René · 06 08 80 47 65  
Assistante, Sarah Galizzi · 04 90 74 73 61

## Nord - Picardie

Barbara Cheysens · 06 31 59 64 07  
Assistante, Anaïs Truphémus · 04 90 74 73 94

## Champagne - Ardennes

Matthieu Mairie · 06 79 47 06 26  
Assistante, Anaïs Truphémus · 04 90 74 73 94

## Alsace - Lorraine

Olivier Radreaux · 06 07 67 39 46  
Assistante, Morgane Bonelli · 04 90 74 70 47

## Savoie - Haute Savoie

Maëva Rigoureux · 06 42 56 43 70  
Assistante, Stéphanie Imbert · 04 90 74 96 22

## Rhône - Sud Bourgogne - Jura - Isère - Loire

Soizic De Vanel · 06 70 12 41 62  
Assistante, Delphine Borel · 04 90 74 96 24

## Bourgogne - Centre - Limousin - Auvergne

Maxime Bavouzet · 06 78 52 33 82  
Assistante, Stéphanie Imbert · 04 90 74 73 90

## Bouches-du-Rhône - Var

Xavier Le Penven · 06 84 02 80 04  
Assistante, Delphine Borel · 04 90 74 96 24

## Côte d'Azur - Monaco

Bruno Morin · 06 37 62 41 21  
Assistante, Stéphanie Imbert · 04 90 74 96 22

## Vaucluse - Ardèche - Cantal - Haute Loire - Drôme

Delphine Ha · 06 48 79 99 62  
Assistante, Delphine Borel · 04 90 74 96 24

## Occitanie - Pyrénées - Méditerranée - Aveyron

Justine Gausson · 06 47 04 59 85  
Assistante, Sandrine Sarrazin · 04 90 74 70 45

## Sud-Ouest

Nicolas Montenon · 07 85 88 19 50  
Assistante, Sandrine Sarrazin · 04 90 74 70 45

## Pays de Loire - Poitou

Sophie Pintiaux · 06 85 23 77 43  
Assistante, Stéphanie Imbert · 04 90 74 96 22

## Bretagne - Basse Normandie

Régis Danais · 06 30 07 35 09  
Assistante, Nadège David · 04 90 74 73 60

## Corse

M. Gabbiati Fabrice · 06 29 31 51 19  
Nadège Dauberte · 04 90 74 73 63



## **Blachere Illumination s.a.s**

22 Allée des Bourguignons  
84400 Apt - France  
tél : +33 (0) 413 068 002  
fax : +33 (0) 490 747 367  
sales@blachere-illumination.com  
www.blachere-illumination.com

**Géraldine** - tél : +33 (0) 490 747 323  
geraldine@blachere-illumination.com

**Léa** - tél : +33 (0) 490 747 642  
l.alves@blachere-illumination.com

**Marion** - tél : +33 (0) 490 747 330  
marion@blachere-illumination.com

**Irène** - tél : +33 (0) 490 747 396  
i.baravet@blachere-illumination.com

**Marie** - tél : +33 (0) 490 747 044  
marie@blachere-illumination.com

**Cathy** - tél : +33 (0) 490 747 325  
cathy@blachere-illumination.com

# Blachere *international*

## **Afrique/Africa**

Blachere Illumination Afrique  
Rue du Caire - Route de M'Saken  
4081 Zaouiet Sousse - Tunisie  
tel : +216 73 386 601  
fax : +216 73 386 650  
email : gregory.roux@blachere-factory.com

## **Asie Pacifique/Asia Pacific**

Blachere Illumination Asia Pacific  
Unit B, 17/F., United Centre  
95 Queensway, Admiralty,  
Hong Kong  
email : hkoffice@blachere-illumination.com

## **Autriche/Austria & Allemagne/Germany**

Blachere Illumination GmbH  
Krenglbacher Straße 7- 4631 Krenglbach  
tel : +43 (0) 7249 46400 – 0  
email : office@blachere.at

## **Belgique/Belgium**

Blachere Illumination Belgique  
Z.I. des hauts sarts  
Rue de Hermée 225, 4040 Herstal  
tel : +32 4 275 02 81  
email : info@blachere-illumination.be

## **Brésil/Brasil**

Blachere Iluminação Brasil  
Estrada Antiga de Itu, 1111  
CEP: 06695-570 Itapevi - São Paulo  
tel : +55 11 94772-7571  
email : paulo.braga@blachere-illumination.com.br

## **Canada/Canada**

Blachere Illumination Canada  
3400 14th Avenue, Unit 18  
Markham, Ontario L3R 0H7  
tel : +1 905 475 6553  
email : info@blachere-illumination.ca

## **Colombie/Colombia**

Blachere - City Lights  
Carrera 33N. 19-26 - Bogotá  
tel : +57 601 646 6000  
email : jklahr@blachere.co  
comercial@blachere.co

## **Croatie/Croatia**

Blachere Illumination Croatia  
Gospodari svjetla d.o.o.  
Medsave 4B  
10430 Samobor  
tel : +385 1 8877 660  
email : info@gospodarisvjetla.hr

## **Danemark/Denmark**

Blachere Illumination - JADA GROUP APS  
Norgesvej 2  
6230 Røddekro  
tel : +45 70 20 00 03  
email : info@jadagroup.dk

## **Espagne/Spain**

Blachere Iluminación España s.a  
Calle Corazón de María, 70-8E  
28002 Madrid  
tel : +34 91 388 28 77  
email : info@blachere-illumination.es

## **États-Unis/USA**

Blachere Illumination USA Inc.  
PO Box 41, 4198 State Highway 14 W  
Christopher, IL 62822  
tel : +1 618 724 1500 - fax : +1 618 724 4500  
email : info@blachere-illumination.us

## **Europe Centrale/Central Europe**

Blachere Illumination Central Europe  
Karadžičova 8/A  
Bratislava 821 08, Slovakia  
tel : + 421 918 428 040  
email : info@blachere-illumination.sk

## **Finlande/Finland**

Blachere Illumination Finland - Lohikari  
Ruoholahdenkatu 24  
00180 Helsinki  
tel : +358 9 565 7750  
email : lohikari@lohikari.fi

## **Hongrie/Hungary**

Blachere Illumination Hungary  
H-2142, Nagytarcsa, Csonka János út 4, K  
épület  
tel : +36 70 389 1475  
email : info@blachere-illumination.hu

## **Italie/Italia**

Blachere Illumination Italia – Lumiworks Srl  
Via Euippa 22  
73100 Lecce  
tel : +39 376 0563212  
email : info@lumiworks.it

## **Mexique/Mexico**

Blachere Iluminación México  
3 Oriente No. 416 Centro.  
74200 Atlixco, Puebla. México.  
tel : +52 244 44 51 281  
email : contacto@blachere.com.mx

## **Moyen-Orient/Middle East**

Blachere Illumination Middle East  
FAB Property Management Buildings  
Building 22 Warehouse 3 DIP 1  
Dubai - United Arab Emirates  
tel : +971 4 254 8856 - mobile: +971 50 506  
92 31  
email : m.soltay@blachere-illumination.ae

## **Norvège/Norway**

Blachere Illumination Norway - Eurosign  
Stanseveien 21  
0975 Oslo  
tel : +47 23 00 85 00  
email : salg@eurosign.no

## **Pays-Bas/Netherlands**

Blachere Illumination Netherlands - Avontuur  
Blokdijk 3 - 1608 HH Wijdenes  
tel : +31 229 50 12 22  
email : info@avontuur.net

## **Pologne/Poland**

Blachere Illumination Polska  
Jasna 39 - 86-070 Czemlewo  
tel : +48 790 785 896  
email : info@blachere-illumination.pl

## **Portugal/Portugal**

Blachere Portugal - Comércio de iluminação Lda  
Variante de Cernache - IC2, Km 184 – Antanhol  
3040-573 Coimbra  
tel : +351 239 487 030  
email : info@blachere-illumination.pt

## **Rép. Tchèque/Czech Republic**

Blachere Illumination Czech Republic  
Ostrá Horka I/511 - 760 01 ZLÍN  
tel : +420 602 227 226  
email : pesek@blachere-illuminations.cz

## **Roumanie/Romania**

Blachere Illumination Romania  
Cluj Napoca, Str. Anatole France, nr. 22, et. 2  
birou 2, Judetul Cluj, cod postal 400463  
tel : +40 75 705 08 66 - fax : + 40 31 845 13 73  
email : office@blachere-illumination.ro

## **Royaume-Uni/UK**

Blachere Illumination UK Ltd  
Gladstone Place, Ladybank, Fife, KY15 7LB  
tel : +44 (0)1337 832 910  
email : sales@blachere-illumination.co.uk

## **Suède/Sweden**

Blachere Illumination Sweden  
Gustavslundsvägen 143,  
167 51 Bromma  
tel : +46 (0)72 601 66 46  
email : andreas.phamgia@blachere-illumination.se

## **Suisse/Switzerland**

Blachere Illumination Swiss SA  
Route de Denges 28C  
CH - 1027 Lonay  
tel : + 41 21 886 00 90  
email : office@blachere-illumination.ch

## **Turquie/Turkey**

Blachere Illumination Aydınlatma  
Hasanpaşa Mh. Lavanta Sk.  
Polat İs Merk.26/3  
Kadıköy-Istanbul  
tel : +90 532 660 69 23  
email : msoltay@blachere-illumination.com.tr

# SEASONS & URBAN COLLECTION 2024

*Browse our collections of decorations for the summer as well as for your events and activities throughout the year.*



# Going paper-free

Here at Blachere, above and beyond just being deeply concerned about sustainable development and our carbon footprint, we are constantly looking for ways to increase the efficiency of the tools we use, which has naturally led us towards going paper-free.

Though the «zero paper» business is somewhat of a Utopian ideal, going paper-free considerably reduces the amount of printouts we produce and, as a consequence, our impact on the environment. The paper tools we do continue to use are printed on paper from sustainably managed forests at our «Imprim'vert» accredited printers.

Our interactive catalogue, available on our website or by email on request, gives you access to multiple additional media: videos of our decorations and installations, how they look in the daytime, work in progress photos and technical information about the products.

Visit us at [www.blachere-illumination.com](http://www.blachere-illumination.com)



